



F
r
e
e
B
e
n
c
h

LED WALL WASHER

Panoray™



ClearTech™

- Adapwire™
- SegPCB™
- ZagLiu™



IK10
Protection



IP67
Protection



Ta
-40°C-55°C



Anti-UV

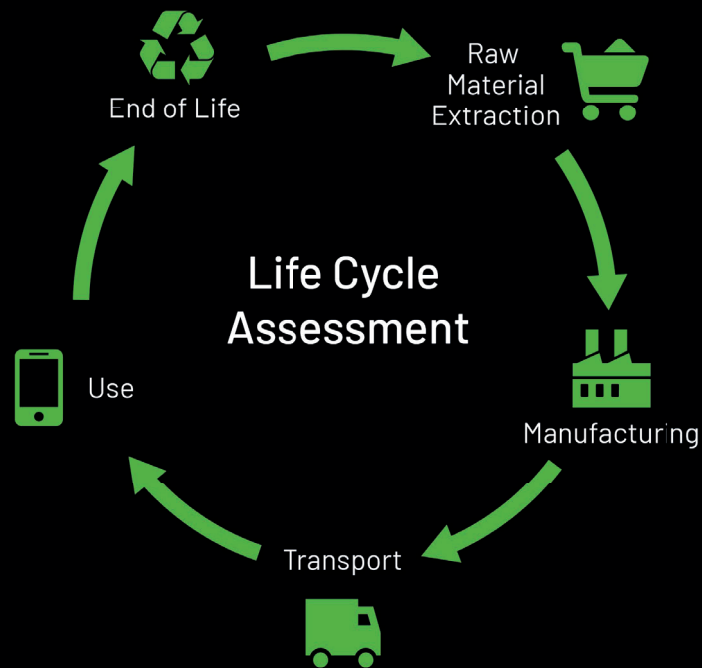

SUSTAINABILITY

Environmental Product Declarations

An EPD is a summary of the lifecycle assessment (LCA) for a product from material extraction to production, shipping, consumption and disposal. CLEAR EPD-verified products allow architects, designers, building contractors etc. to compare and evaluate the lifetime sustainability of construction products and materials.

By making our products transparent on the environmental impact, we hope to have a positive impact on the living environment and people's well-being.

Let the light wash over any curvature of the wall

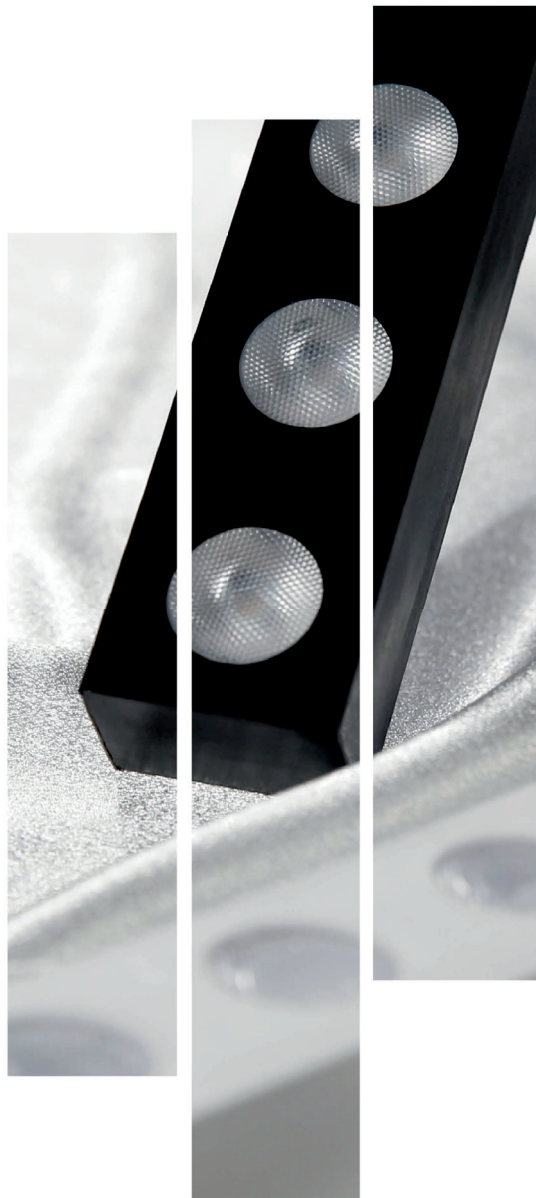

Elevated visual harmony,
ensuring timeless
elegance.



Consistent glow at the
joint due to the same
lens pitch.



Sustained color brilliance
with effortless
self-cleaning.



Specialized lens and silicone
casing to withstand UV and
heat.



Boosted lifespan with
efficient heat
management.



Built to last.
No PCB fracture, reducing
maintenance needs.

Panaray™, part of FreeBend™ Series, adopts an exquisite look and gives a delicate touch. But there is so much more than meets the eye. The supple Wall Washer follows and conforms seamlessly to the contour of every corner and curvy surface, dispersing a uniform and smooth wash of light without adding scallops and light spills on the surface.

SPECIFICATION



Ambient Working Temperature
-40~55°C / -40~13 °F



Storage Temperature
-40 ~ 60°C / -40 ~ 140°F

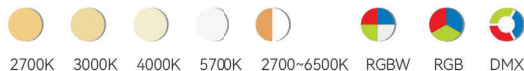

Ambient Installation Temperature
> -40°C / -40°F



Max. Mounting Surface Temperature
85°C / 185°F

Dimension

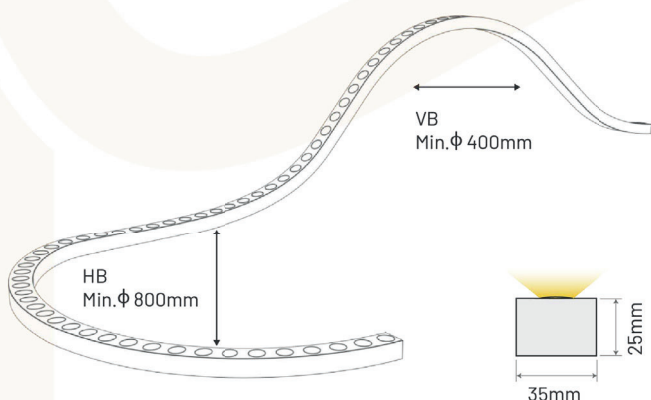

Standard Length

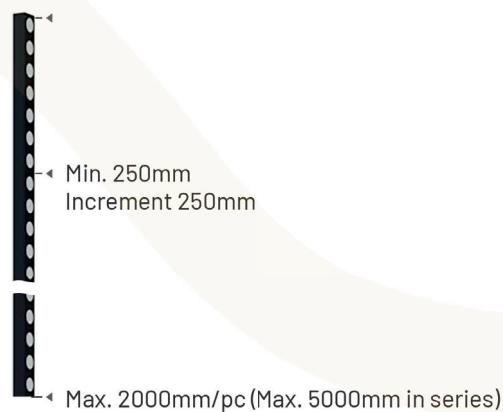

Parameter

Working Voltage	DC24V
Rated Power/m	24W
LED Qty/m	28LEDs
IP Rating	IP67
IK Rating	IK10
CRI	80
Weight/m	1100g

Note: 10-Year warranty is available for monochrome series only and it's subject to terms and conditions.

Illuminance Simulation

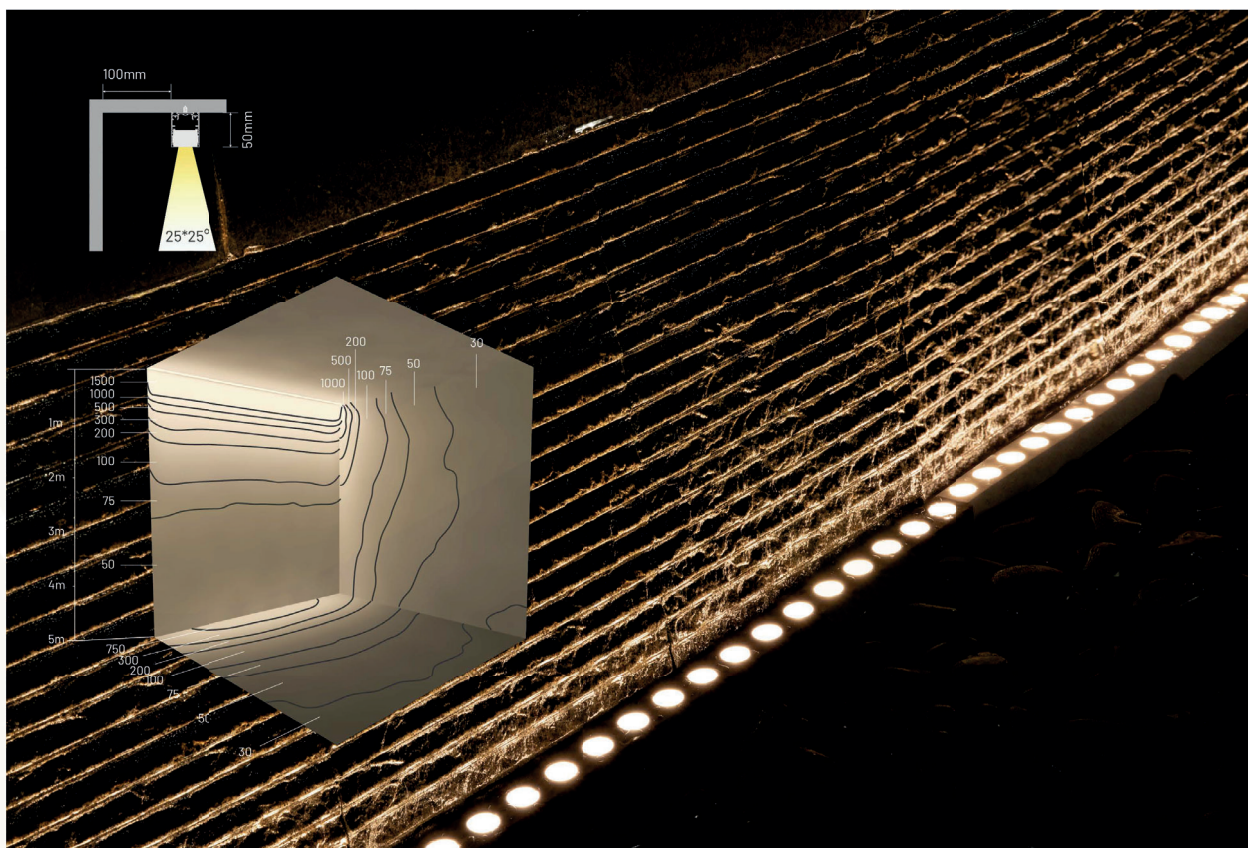

PRODUCT NOMENCLATURE

Panaray3525- 15*25° - W30/R80 -24VDC- 24W - 28 - 250 - WW



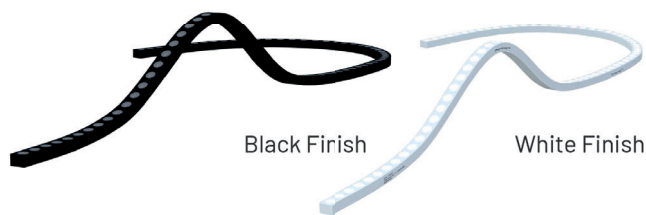

Model Name	Optic Lens	Pixel Qty Per Meter/ Input Signal/ Light Color/CRI	Voltage	Power/m	LED Quantity /m	Min. Cutting Length (mm)	Finish
Panaray =Trademark 3525 =Dimension W35*H25	12°	W27/80 =2700K/80 W30/80 =3000K/80 W40/80 =4000K/80 W57/80 =5700K/80	DC24V	24W	28	250	WW = White Base & White Light Surface DD = Black Base & Black Light Surface
	25°	D27-65/R80 =2700-6500K/80 RGB =RGB RGBW30/80 =RGBW(3000K)/80					
	15*25°	4DMX(W27/80) =4/DMX/2700K/80 4DMX(W30/80) =4/DMX/3000K/80 4DMX(W40/80) =4/DMX/4000K/80 4DMX(W57/80) =4/DMX/5700K/80 4DMX(D27-65/80) =4/DMX/2700-6500K/80					
	15*40°	4DMX(RGB) =4/DMX/RGB 4DMX(RGBW30/80) =4/DMX/RGBW(3000K)/80					
	15*60°						
	20*40°						

RGB  RGBW 

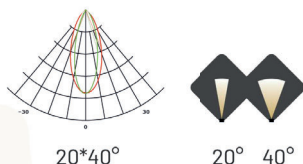

PHOTOMETRIC CURVE



Item Code	Finished Product				
	Optic Lens	CCT/Color	Wavelength/ CCT Tolerance	Lumen/m	Lumen/ft
Panoray3525-20*40°-RGB-DC24V-24W-28-250-DD	20*40°	 Red	619-624nm	>125	>38
		Green	520-535nm	>280	>85
		Blue	460-475nm	>60	>18
		RGB	/	>465	>142
Panoray3525-20*40°-RGB-DC24V-24W-28-250-WW	20*40°	 Red	619-624nm	>150	>46
		Green	520-535nm	>340	>104
		Blue	460-475nm	>75	>23
		RGB	/	>565	>172
Panoray3525-20*40°-RGBW30/R80-DC24V-24W-28-250-DD	20*40°	 Red	619-624nm	>100	>30
		Green	520-535nm	>225	>69
		Blue	460-475nm	>60	>18
		RGB	/	>385	>117
		3000K	3045±175K	>290	>88
Panoray3525-20*40°-RGBW30/R80-DC24V-24W-28-250-WW	20*40°	 Red	619-624nm	>115	>35
		Green	520-535nm	>265	>81
		Blue	460-475nm	>75	>23
		RGB	/	>455	>139
		3000K	3045±175K	>350	>107

DMX512CN

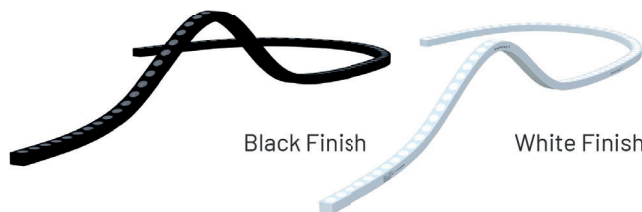

Black Finish

White Finish

PHOTOMETRIC CURVE

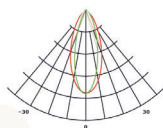

20*40°



20° 40°

Item Code	Finished Product				
	Optic Lens	CCT/Color	Wavelength/ CCT Tolerance	Lumen/m	Lumen/ft
Panoray3525-20*40°-4DMX(RGB)-24VDC-24W-28-250-DD	20*40°	Red	619-624nm	>115	>35
		Green	520-535nm	>270	>82
		Blue	460-475nm	>30	>9
		RGB	/	>415	>127
Panoray3525-20*40°-4DMX(RGB)-24VDC-24W-28-250-WW	20*40°	Red	619-624nm	>145	>44
		Green	520-535nm	>335	>102
		Blue	460-475nm	>80	>24
		RGB	/	>560	>171
Panoray3525-20*40°-4DMX(RGBW30/R80)-24VDC-24W-28-250-DD	20*40°	Red	619-624nm	>80	>24
		Green	520-535nm	>230	>70
		Blue	460-475nm	>70	>21
		RGB	/	>380	>116
		3000K	3045±175K	>315	>96
Panoray3525-20*40°-4DMX(RGBW30/R80)-24VDC-24W-28-250-WW	20*40°	Red	619-624nm	>100	>30
		Green	520-535nm	>275	>84
		Blue	460-475nm	>85	>26
		RGB	/	>460	>140
		3000K	3045±175K	>380	>116

CONNECTOR

IP67 Silicone Injection Moulded Connector

Tolerance: ±0.5mm

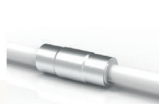

Anti-wicking Ferrule

Note: Warranty will void if it's removed and cause the water ingress.

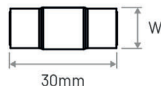

B/D series, W=12mm
A/E/S series, W=15mm



Male & Female Connector

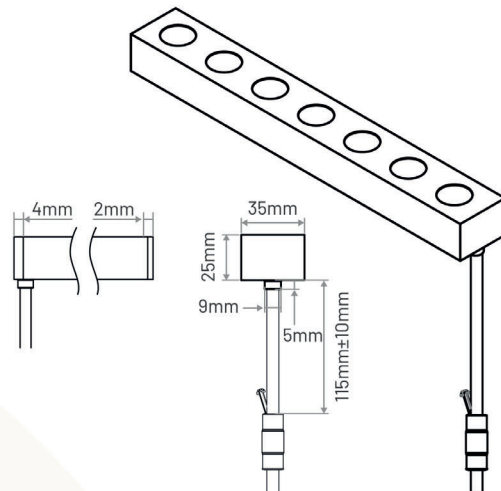
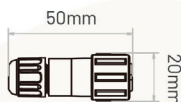

PROFILE

Serrated Aluminum Profile H36

Available Lengths:
50mm, 500mm, 1000mm, 2000mm

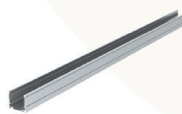

Tolerance: ±0.3mm

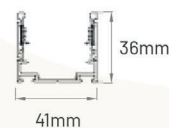

Serrated Aluminum Profile H50

*With Cable Raceway

Available Lengths:
50mm, 500mm, 1000mm, 2000mm

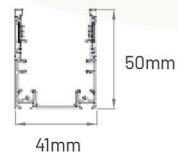
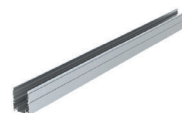

Bendable Serrated Aluminum Profile H36 (HB)

Min. Bending Diameter Φ1200mm

Available Lengths: 1000mm

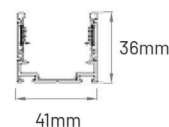

Note: it's IK08 rated when the light is put in this type of mounting profile.

Bendable Serrated Aluminum Profile H36 (VB)

Min. Bending Diameter Φ2000mm

Available Lengths: 1000mm

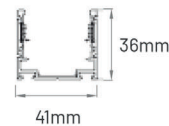
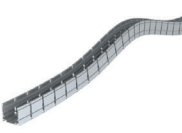

Note: it's IK08 rated when the light is put in this type of mounting profile.

Adjustable Mounting Bracket

* 180° Rotation

* 304 Stainless Steel

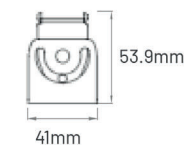

Note: its rotation angle will be restricted if the bracket is applied to the bending profile.

Bendable Aluminum Glare Shield (HB)

Min. Bending Diameter Φ1200mm

Available Lengths: 1000mm, 2000mm

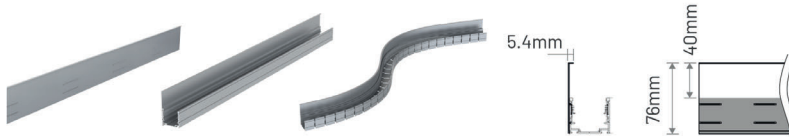

Note: it's not suitable for the vertical bending profile.