

NEKO / SENSE 45 / S45S1
Adjustable LED Downlight

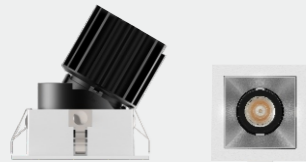

4W	CRI90	2700K 3000K 4000K	330lm 350lm 380lm	18°	24°	35°	50°
45x45	35°	IP20	UGR < 19	CREE	50,000h@L80	5 YEAR GUARANTEE	CE

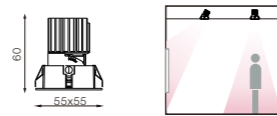

Kurze Info

- Einmaliges, modulares und flexibles Einbauleuchtersystem
- Quadratischer Einbaurahmen
- Verschiedene Zweitreflektorfarben stehen zur Auswahl
- beste Lichtqualität mit hervorragendem Sehkomfort

Short Info

- Modular designed downlight system
- Square trim
- Varied color for secondary reflector
- Anti glare accessories for maximum eye confort

Features

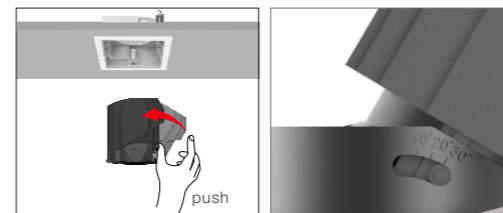

· Mechanical 0-30° tilt

Order Information

S45S1-4W

CREE LED powered by 350mA constant current LED driver, White trim, Matt reflector

Model	LED Power	System Power	LED Voltage	LED Current	CRI	CCT	BEAM	LED output	System output	Code
S45S1-4W-930-18D	4 W	6 W	12 V	350 mA	90	3000K	18°	500 lm	350 lm	SUS1-9301804X-WM
S45S1-4W-940-18D	4 W	6 W	12 V	350 mA	90	4000K	18°	550 lm	380 lm	SUS1-9401804X-WM
S45S1-4W-930-24D	4 W	6 W	12 V	350 mA	90	3000K	24°	500 lm	350 lm	SUS1-9302404X-WM
S45S1-4W-940-24D	4 W	6 W	12 V	350 mA	90	4000K	24°	550 lm	380 lm	SUS1-9402404X-WM
S45S1-4W-930-35D	4 W	6 W	12 V	350 mA	90	3000K	35°	500 lm	350 lm	SUS1-9303504X-WM
S45S1-4W-940-35D	4 W	6 W	12 V	350 mA	90	4000K	35°	550 lm	380 lm	SUS1-9403504X-WM
S45S1-4W-930-50D	4 W	6 W	12 V	350 mA	90	3000K	50°	500 lm	350 lm	SUS1-9305004X-WM
S45S1-4W-940-50D	4 W	6 W	12 V	350 mA	90	4000K	50°	550 lm	380 lm	SUS1-9405004X-WM

Remark: X= F (ON-OFF) X= P (Phase Dim) X= A (1-10V Dim) X= D (DALI Dim)

Optional accessory



Optional Trims



Light Distribution

3000K

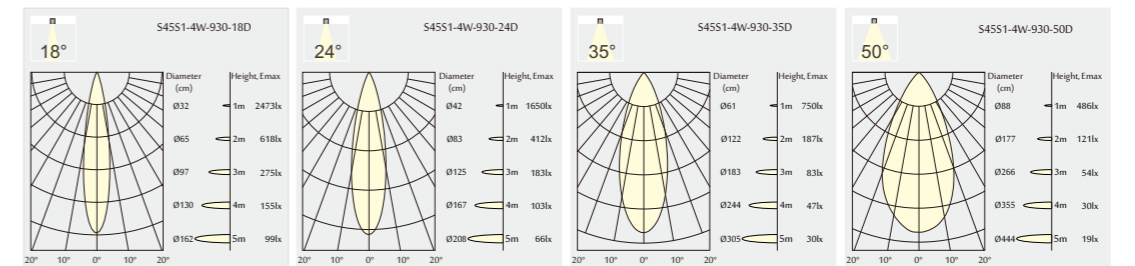

For more info see: www.nekolighting.com

NEKO / SENSE 68 / S68S1
Adjustable LED Downlight

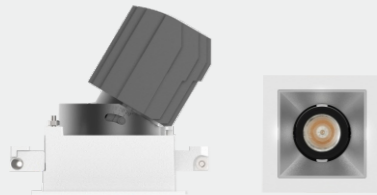
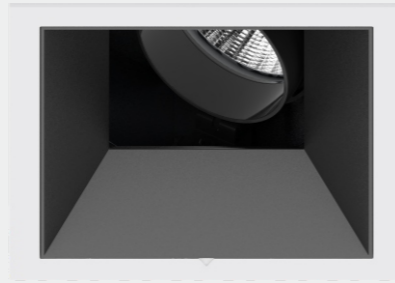

11W 7.5W	CRI90	2700K 3000K 4000K	780lm 800lm 850lm	10° 24° 40° 55°
68x68 355°	CITIZEN 50,000h@L80	IP20	UGR < 19	5 YEAR WARRANTY CE

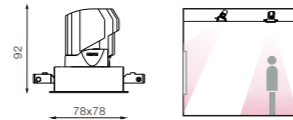

Kurze Info

- Einmaliges, modulares und flexibles Einbauleuchensystem
- Quadratischer Einbaurahmen/ Rahmenlos
- Verschiedene Zweitreflektorfarben stehen zur Auswahl
- Sense bietet beste Lichtqualität mit hervorragendem Sehkomfort
- LED 2-step MacAdam

Short Info

- Modular designed downlight system
- Square trim/ trimless
- Varied color for secondary reflector
- Anti glare accessories for maximum eye confort
- LED 2-step MacAdam

Features

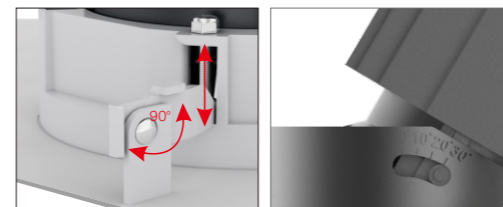

· Ceiling thickness: 1mm-12mm-25mm · Mechanical 0-30° tilt

Order Information

S68S1-7.5W

CITIZEN LED pwered by 250mA constant current LED driver, White trim, Specular reflector

Model	LED Power	System Power	LED Voltage	LED Current	CRI	CCT	BEAM	LED output	System output	Code
S68S1-7.5W-930-24D	7.5 W	9 W	31 V	250 mA	90	3000K	24°	850 lm	600 lm	STS1-9302408X-WS
S68S1-7.5W-940-24D	7.5 W	9 W	31 V	250 mA	90	4000K	24°	900 lm	650 lm	STS1-9402408X-WS
S68S1-7.5W-930-40D	7.5 W	9 W	31 V	250 mA	90	3000K	40°	850 lm	600 lm	STS1-9304008X-WS
S68S1-7.5W-940-40D	7.5 W	9 W	31 V	250 mA	90	4000K	40°	900 lm	650 lm	STS1-9404008X-WS
S68S1-7.5W-930-55D	7.5 W	9 W	31 V	250 mA	90	3000K	55°	850 lm	600 lm	STS1-9305508X-WS
S68S1-7.5W-940-55D	7.5 W	9 W	31 V	250 mA	90	4000K	55°	900 lm	650 lm	STS1-9405508X-WS

S68S1-11W

CITIZEN LED pwered by 350mA constant current LED driver, White trim, Specular reflector

Model	LED Power	System Power	LED Voltage	LED Current	CRI	CCT	BEAM	LED output	System output	Code
S68S1-11W-930-24D	11 W	13 W	31 V	350 mA	90	3000K	24°	1100 lm	800 lm	STS2-9302411X-WS
S68S1-11W-940-24D	11 W	13 W	31 V	350 mA	90	4000K	24°	1200 lm	850 lm	STS2-9402411X-WS
S68S1-11W-930-40D	11 W	13 W	31 V	350 mA	90	3000K	40°	1100 lm	800 lm	STS2-9304011X-WS
S68S1-11W-940-40D	11 W	13 W	31 V	350 mA	90	4000K	40°	1200 lm	850 lm	STS2-9404011X-WS
S68S1-11W-930-55D	11 W	13 W	31 V	350 mA	90	3000K	55°	1100 lm	800 lm	STS2-9305511X-WS
S68S1-11W-940-55D	11 W	13 W	31 V	350 mA	90	4000K	55°	1200 lm	850 lm	STS2-9405511X-WS

S68S1-8.5W 10°

CREE LED pwered by 700mA constant current LED driver, White trim, Specular reflector

Model	LED Power	System Power	LED Voltage	LED Current	CRI	CCT	BEAM	LED output	System output	NEW Code
S68S1-8.5W-930-10D	8.5 W	10 W	12 V	700 mA	90	3000K	10°	600 lm	350 lm	STS5-9301009X-WS
S68S1-8.5W-940-10D	8.5 W	10 W	12 V	700 mA	90	4000K	10°	650 lm	380 lm	STS5-9401009X-WS

Remark: X= F (ON-OFF) X= P (Phase Dim) X= A (1-10V Dim) X= D (DALI Dim)

Optional trim



Round Trim Standard Round Trimless European Version Round Trimless American Version

Optional accessory



Secondary reflector Specular SA68S Secondary reflector Black SA68B Secondary reflector Matt SA68M Secondary reflector White SA68W Secondary reflector Chrome black SA68CB Secondary reflector Gold SA68G Honeycomb HCS68

Light Distribution

3000K

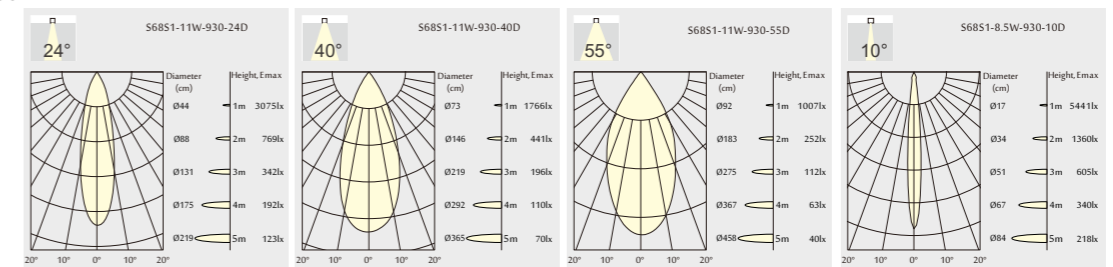

For more info see: www.nekolighting.com

NEKO / SENSE 68 / Square Trim/ S68X2
Adjustable LED Downlight

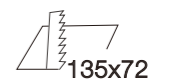
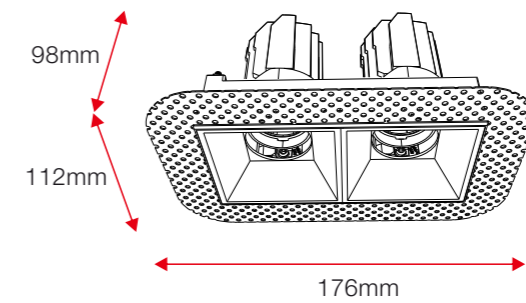
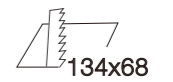
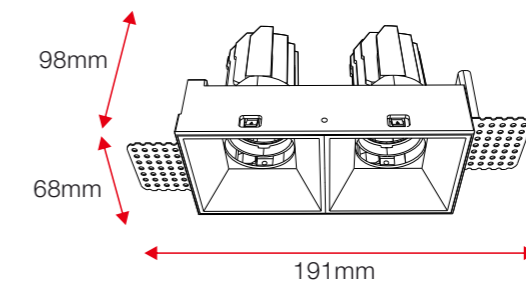
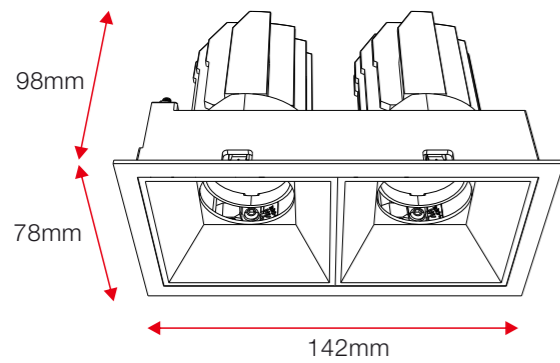
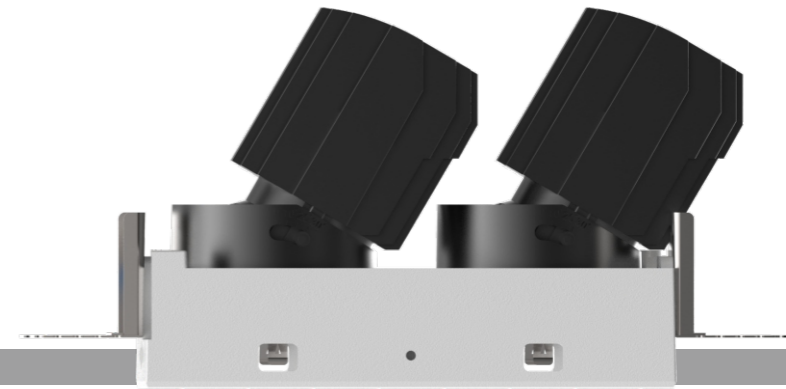
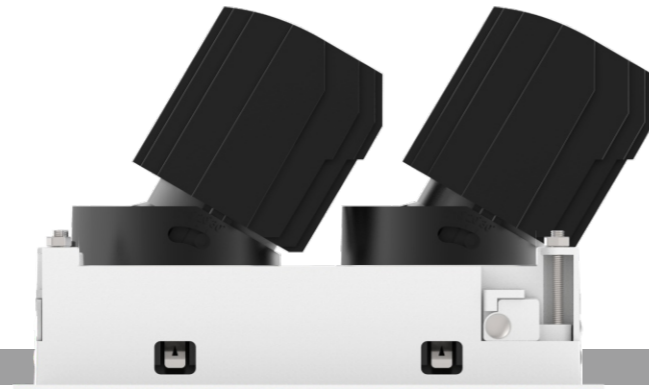
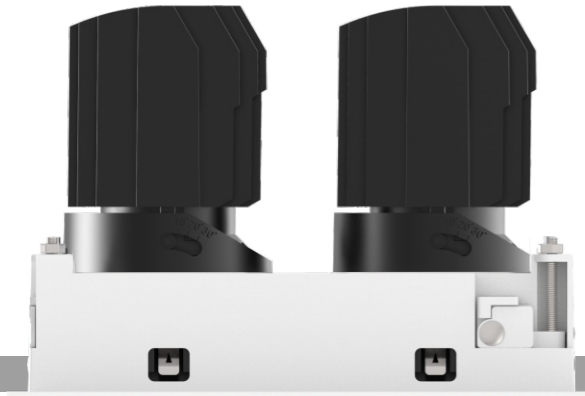
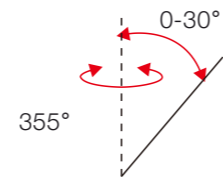
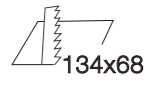

NEKO / SENSE 68 / Square Trim/ S68X3
Adjustable LED Downlight

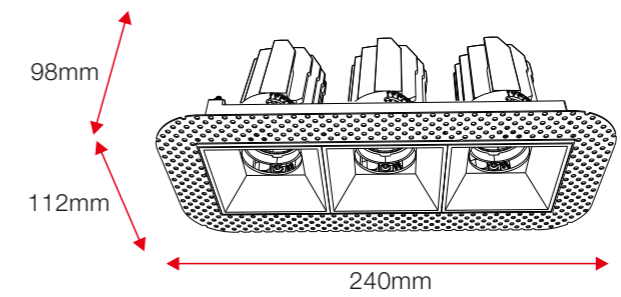
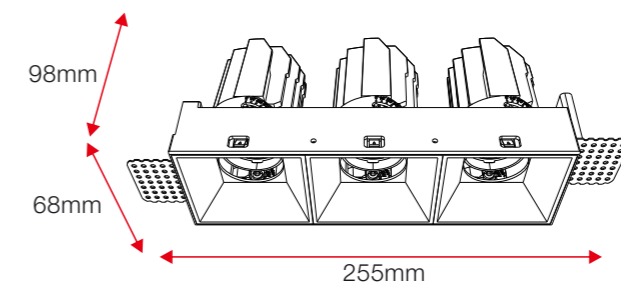
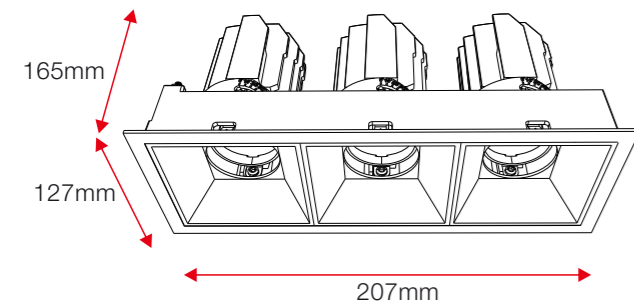
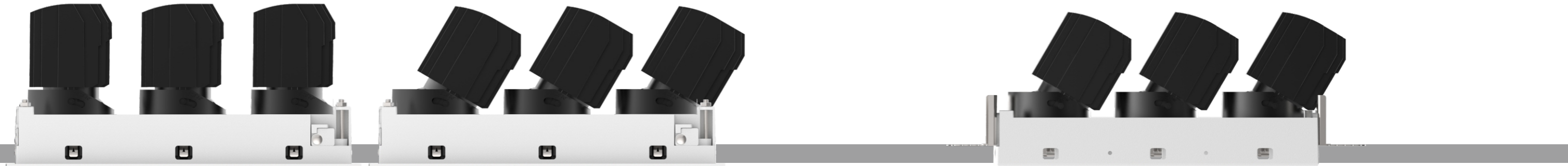
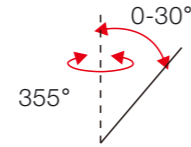
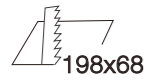

NEKO / SENSE 68 / Square Trim/ S68X4
Adjustable LED Downlight

