

FUSION

The Narrow Linear Downlight Series
Featuring Fixed Downlights,
Adjustable Downlights,
Spotlights,
Wall Washer Downlights,
General Light Downlights.

Project: Eggen Restaurant, Norway



FUSION – The Narrow Linear Downlight Series

Create a circle of light from a line of LED Downlights

A narrow line of nano LED Downlights for pure minimalism

Superior glare control for high performance and visual comfort

Fixed, Adjustable, Wall Washer, General Light, Spotlight and Trimless versions for choice

Aluminum housing and in powder-coated finish, excellent dissipation performance & antirust

LED chip in standard CRI>90 and 3-step MacAdam for perfect color consistency

Color temperature in 2700K, 3000K and 4000K for selection

Different functions LED driver in On-Off, Phase Dim, 1-10V Dim and DALI Dim

Trimless Version



Trim Version



Fixed

Adjustable

Wall Washer

General Light

Spotlight

Trimless Spotlight

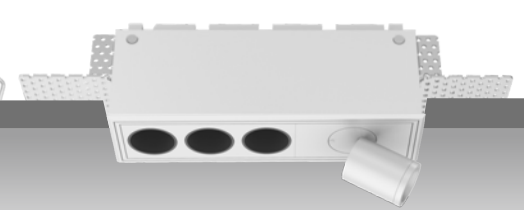
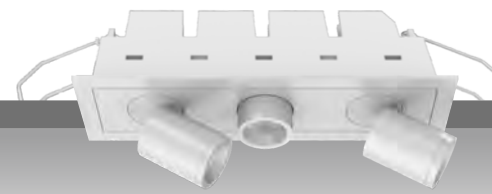
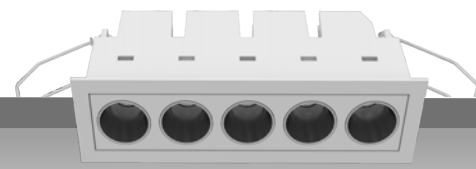

FF1 / 1 LED / 2W / 160 lm



FF2 / 2 LED / 4W / 330 lm



FF3 / 3 LED / 7W / 500 lm



FX4 / 4 LED / 9W / 650 lm



FF5 / 5 LED / 11W / 750 lm



FF10 / 10 LED / 22W / 1650 lm



FF5 / 5 LED / 11W / 750 lm



FF10 / 10 LED / 22W / 1650 lm



FF10 / 10 LED / 22W / 1650 lm

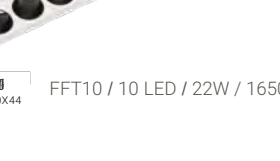

FF10 / 10 LED / 22W / 1650 lm



FA5 / 5 LED / 11W / 750 lm



FA10 / 10 LED / 22W / 1650 lm



-20 +20

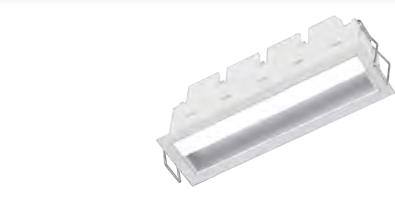

FW5 / 5 LED / 11W / 550 lm



FW10 / 10 LED / 22W / 1200 lm



FWT5 / 5 LED / 11W / 550 lm



FWT10 / 10 LED / 22W / 1200 lm



FWT10 / 10 LED / 22W / 1200 lm



Beam

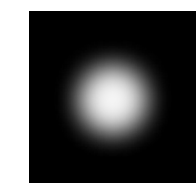

Medium 24°



Wide 40°

Secondary Reflector

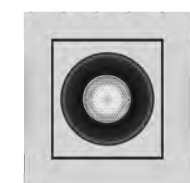

Black

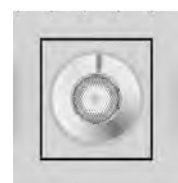

Specular

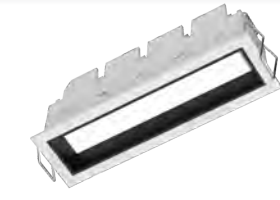

FG5 / 5 LED / 11W / 400 lm

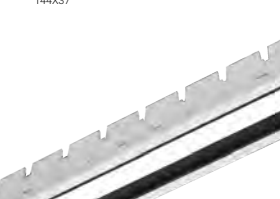

FG10 / 10 LED / 22W / 850 lm



FGT5 / 5 LED / 11W / 400 lm



FGT10 / 10 LED / 22W / 850 lm



FGT10 / 10 LED / 22W / 850 lm



Flood



FS1 / 1 LED / 2W / 160 lm



FS2 / 2 LED / 4W / 330 lm



FS3 / 3 LED / 7W / 500 lm



FS6 / 6 LED / 14W / 900 lm



FF3-FS1 / 4 LED / 9W / 600 lm



FF6-FS2 / 8 LED / 18W / 1200 lm



FST3 / 3 LED / 7W / 500 lm



FST6 / 6 LED / 14W / 900 lm



FFT3-FST1 / 4 LED / 9W / 600 lm



FFT6-FST2 / 8 LED / 18W / 1200 lm

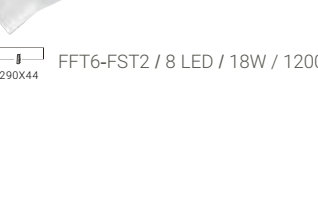

FFT6-FST2 / 8 LED / 18W / 1200 lm

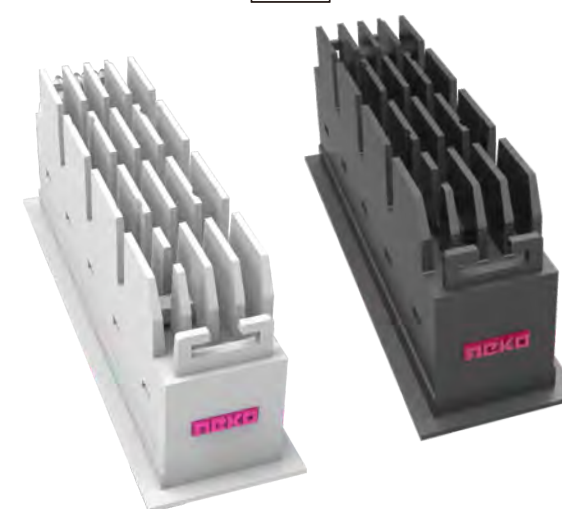



Black Reflector



1 LED / 2W / 160lm



2 LED / 4W / 330lm



3 LED / 7W / 500lm



5 LED / 11W / 750lm



10 LED / 22W / 1650lm

Specular Reflector



1 LED / 2W / 180lm



2 LED / 4W / 360lm



3 LED / 7W / 540lm



5 LED / 11W / 850lm



10 LED / 22W / 1850lm

Secondary Reflector

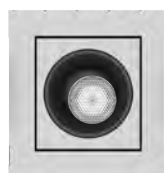

Black

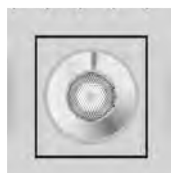

Specular

Beam

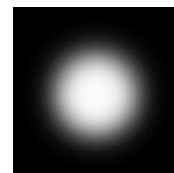

Medium 24°

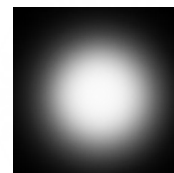

Wide 40°

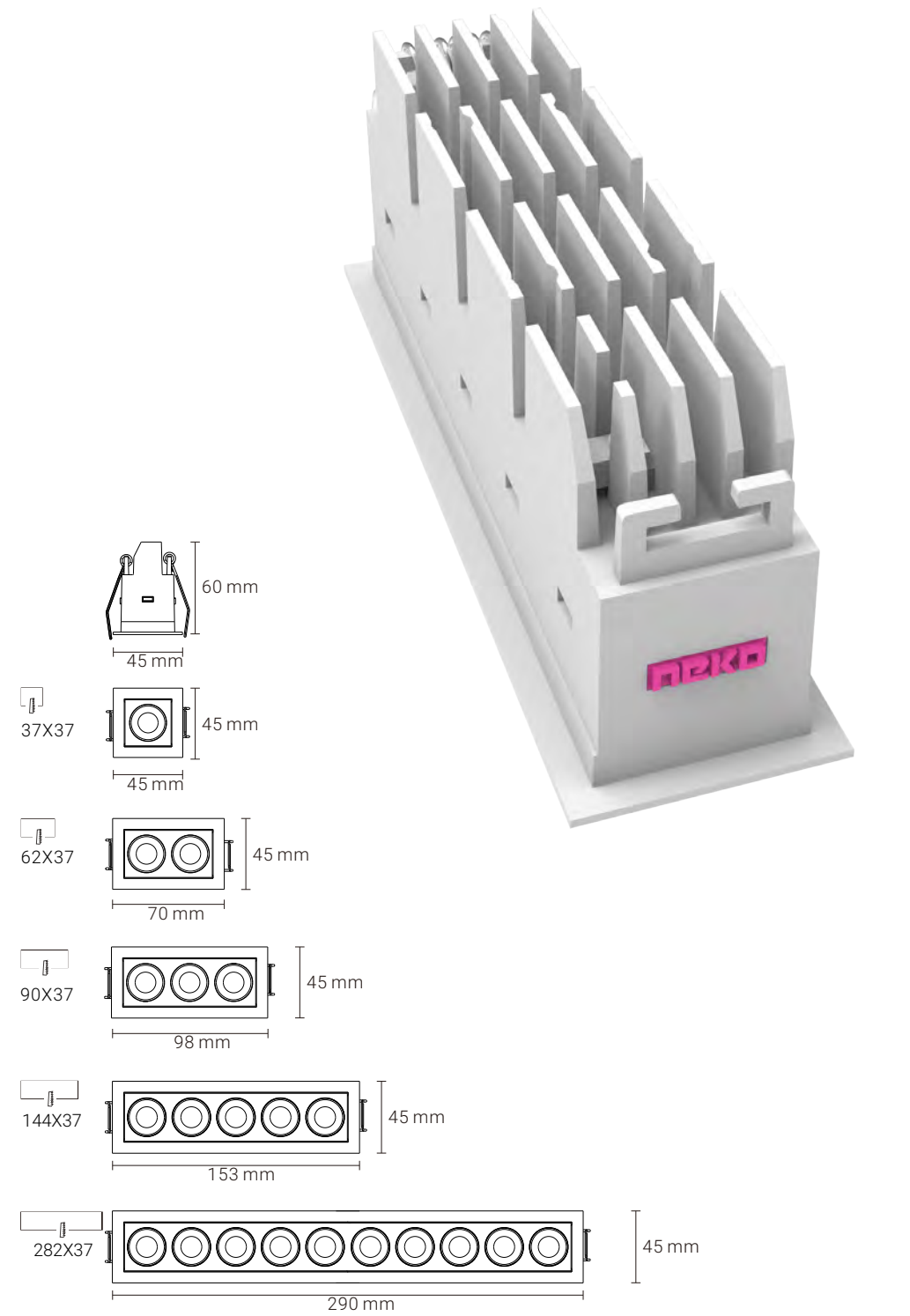



Project: BVLGARI Hotel, Shanghai, China

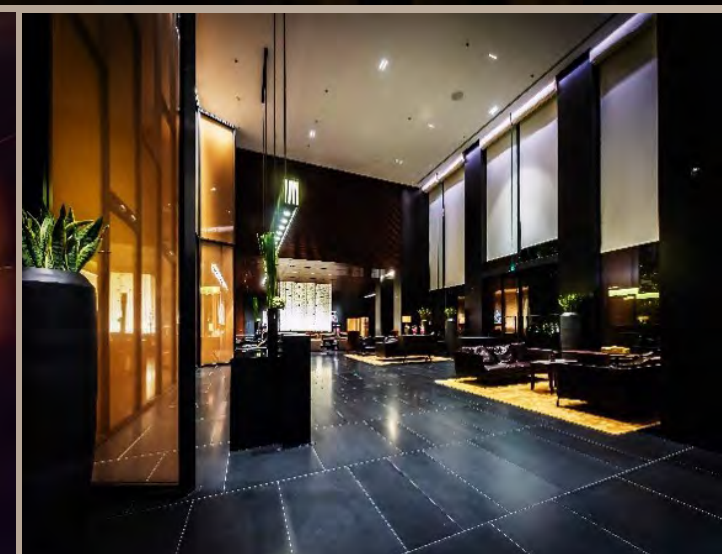

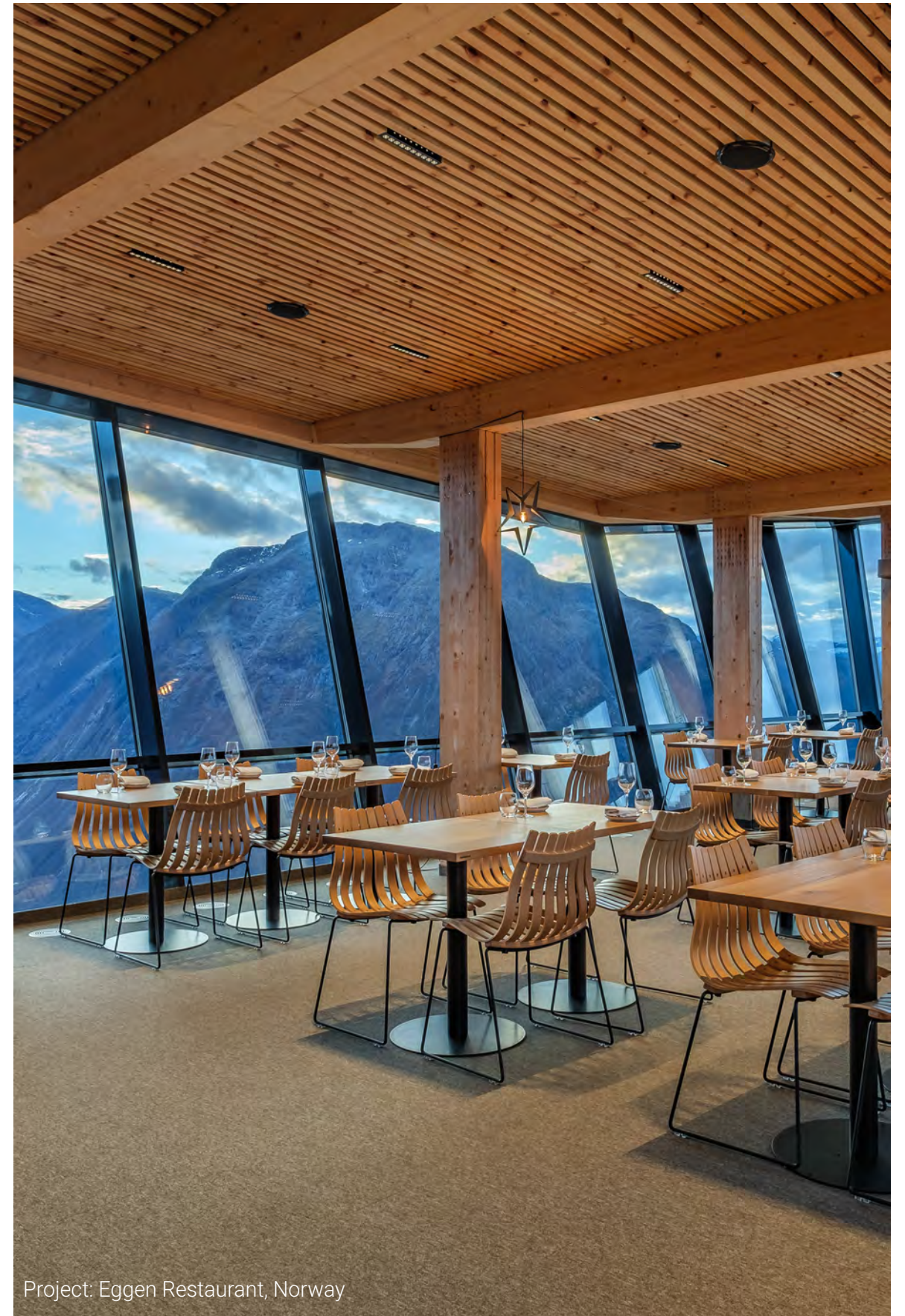

Project: Eggen Restaurant, Norway

FUSION – The Narrow Linear Downlight Series

Project: Oslo Hall, City Hall Gallery, Norway



FUSION FF1 – Fixed LED Downlight

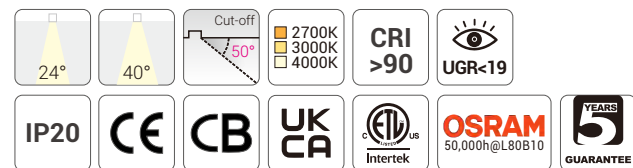

Quick Info

- Ceiling Cut-out: 37x37mm
- OSRAM LED: 2W, CRI>90
- CCT: 2700K, 3000K, 4000K Available as Standard
- Beam Angle: 24°, 40°
- Lumen Output: Up to 160lm System Luminous Flux
- IP Class: IP20
- LED Driver: On-Off, Phase Dim, 1-10V Dim, DALI Dim

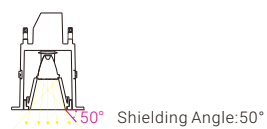
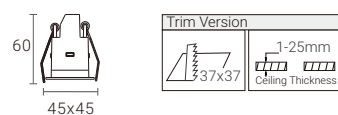

Light Distribution

3000K

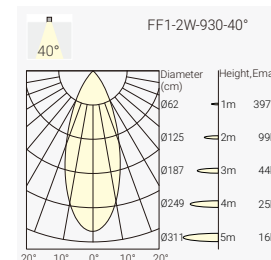
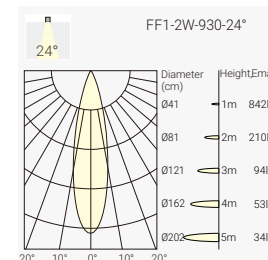

Finish



White



Black

Order Info (FUSION FF1 in White Trim & Black Reflector as an Example)

LED Power	System Power	LED Voltage	LED Current	CRI	CCT	Beam	LED Output	System Output	Code
2W	3W	3V	700mA	90	2700K	24°	200lm	130lm	FF1-9272402N-WB
						40°	200lm	130lm	FF1-9274002N-WB
					3000K	24°	210lm	140lm	FF1-9302402N-WB
						40°	210lm	140lm	FF1-9304002N-WB
					4000K	24°	230lm	155lm	FF1-9402402N-WB
						40°	230lm	155lm	FF1-9404002N-WB

Code Remark: N=N(No Driver) F=F(ON-OFF) P=P(Phase Dim) A=A(1-10V Dim) D=D(DALI Dim)

Coding

Model	CRI/ CCT	Beam Angle	LED Power	Control	Finish	Reflector Color	Accessory
FF1	927	24	02	N	W	B	
FUSION FF1	CRI>90/ 2700K	24°	2W	No Driver	White	Black	
	930	40		F	B		
	CRI>90/ 3000K	40°		On-Off	Black		
	940			P			
	CRI>90/ 4000K			Phase Dim			
				A			
				1-10V Dim			
				D			
				DALI Dim			

Project: Muyang Museum, China



FUSION FF2 – Fixed LED Spotlight

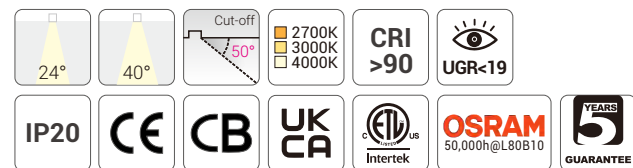

Quick Info

- Ceiling Cut-out: 68x37mm
- OSRAM LED: 4W, CRI>90
- CCT: 2700K, 3000K, 4000K Available as Standard
- Beam Angle: 24°, 40°
- Lumen Output: Up to 330lm System Luminous Flux
- IP Class: IP20
- LED Driver: On-Off, Phase Dim, 1-10V Dim, DALI Dim

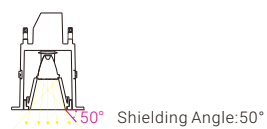
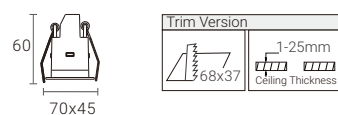

Light Distribution

3000K

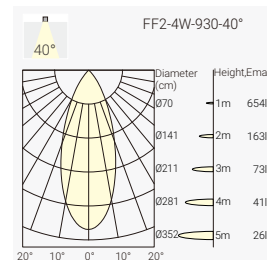
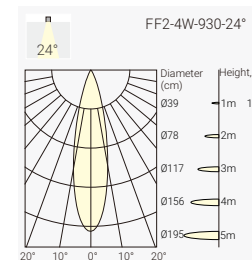

Finish



White

Black

Order Info (FUSION FF2 in White Trim & Black Reflector as an Example)

LED Power	System Power	LED Voltage	LED Current	CRI	CCT	Beam	LED Output	System Output	Code
4W	6W	6 V	700mA	90	2700K	24°	400lm	290lm	FF2-9272404N-WB
						40°	400lm	290lm	FF2-9274004N-WB
					3000K	24°	450lm	300lm	FF2-9302404N-WB
						40°	450lm	300lm	FF2-9304004N-WB
					4000K	24°	500lm	330lm	FF2-9402404N-WB
						40°	500lm	330lm	FF2-9404004N-WB

Code Remark: N=N(No Driver) F=F(ON-OFF) P=P(Phase Dim) A=A(1-10V Dim) D=D(DALI Dim)

Coding

Model	CRI/ CCT	Beam Angle	LED Power	Control	Finish	Reflector Color	Accessory
FF2	927	24	04	N	W	B	
FUSION FF2	CRI>90/ 2700K	24°	4W	No Driver	White	Black	
	930	40		F	B		
	CRI>90/ 3000K	40°		On-Off	Black		
	940			P			
	CRI>90/ 4000K			Phase Dim			
				A			
				1-10V Dim			
				D			
				DALI Dim			

Project: Bvlgari Hotel, Shanghai, China



FUSION FF3 – Fixed LED Spotlight

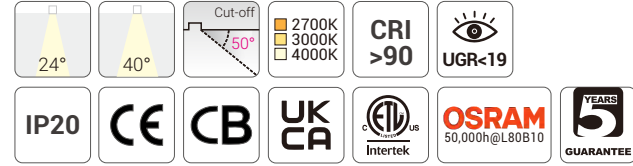

Quick Info

- Ceiling Cut-out: 90x37mm
- OSRAM LED: 7W, CRI>90
- CCT: 2700K, 3000K, 4000K Available as Standard
- Beam Angle: 24°, 40°
- Lumen Output: Up to 500lm System Luminous Flux
- IP Class: IP20
- LED Driver: On-Off, Phase Dim, 1-10V Dim, DALI Dim

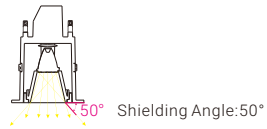
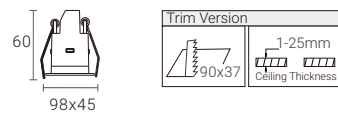

Light Distribution

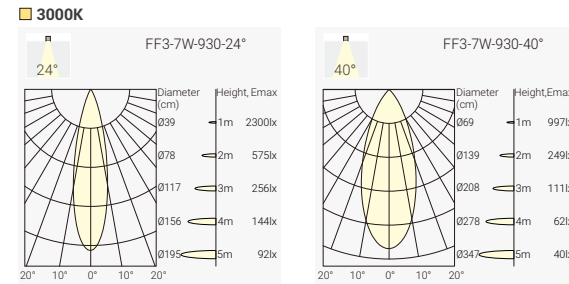

Finish



Order Info (FUSION FF3 in White Trim & Black Reflector as an Example)

LED Power	System Power	LED Voltage	LED Current	CRI	CCT	Beam	LED Output	System Output	Code
7W	9 W	9V	700mA	90	2700K	24°	600lm	420lm	FF3-9272407N-WB
						40°	600lm	420lm	FF3-9274007N-WB
					3000K	24°	650lm	450lm	FF3-9302407N-WB
						40°	650lm	450lm	FF3-9304007N-WB
					4000K	24°	700lm	500lm	FF3-9402407N-WB
						40°	700lm	500lm	FF3-9404007N-WB

Code Remark: N=N(No Driver) F=F(ON-OFF) P=P(Phase Dim) A=A(1-10V Dim) D=D(DALI Dim)

Reflector Options



Coding

Model	CRI/ CCT	Beam Angle	LED Power	Control	Finish	Reflector Color	Accessory
FF3	927	24	07	N	W	B	
FUSION FF3	CRI>90/ 2700K	24°	7W	No Driver	White	Black	
	930	40		F	B	S	
	CRI>90/ 3000K	40°		On-Off	Black	Specular	
	940			P			
	CRI>90/ 4000K			Phase Dim			
				A			
				1-10V Dim			
				D			
				DALI Dim			



Project: Hallunda Station, Sweden

FUSION FF4 – Fixed LED Spotlight

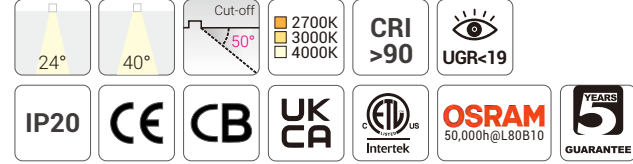

Quick Info

- Ceiling Cut-out: 65x65mm
- OSRAM LED: 9W, CRI>80, CRI>90
- CCT: 2700K, 3000K, 4000K Available as Standard
- Beam Angle: 24°, 40°
- Lumen Output: Up to 650lm System Luminous Flux
- IP Class: IP20
- LED Driver: On-Off, Phase Dim, 1-10V Dim, DALI Dim, Casambi Wireless Dim

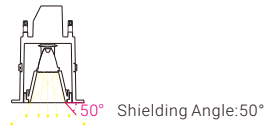
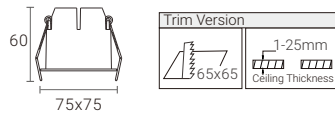

Light Distribution

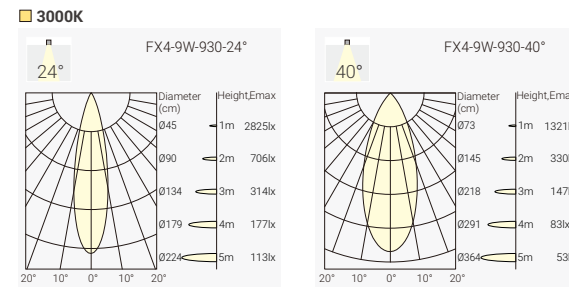

Finish



Order Info (FUSION FX4 in White Trim & Black Reflector as an Example)

LED Power	System Power	LED Voltage	LED Current	CRI	CCT	Beam	LED Output	System Output	Code
9W	11W	12V	700mA	90	2700K	24°	750lm	550lm	FX4-9272409N-WB
					3000K	24°	750lm	550lm	FX4-9274009N-WB
					4000K	24°	800lm	600lm	FX4-9302409N-WB
						40°	800lm	600lm	FX4-9304009N-WB
						24°	900lm	650lm	FX4-9402409N-WB
						40°	900lm	650lm	FX4-9404009N-WB

Code Remark: N=N(No Driver) F=F(ON-OFF) P=P(Phase Dim) A=A(1-10V Dim) D=D(DALI Dim)

Reflector Options



Coding

FF4 - *** ** ** * - * * - *

Model	CRI/ CCT	Beam Angle	LED Power	Control	Finish	Reflector Color	Accessory
FX4	927	24	09	N	W	B	
FUSION FX4	CRI>90/ 2700K	24°	9W	No Driver	White	Black	
	930	40		F	B	S	
	CRI>90/ 3000K	40°		On-Off	Black	Specular	
	940			P			
	CRI>90/ 4000K			Phase Dim			
				A			
				1-10V Dim			
				D			
				DALI Dim			

Project: Office Helsinki, Finland



FUSION FF5 – Fixed LED Spotlight

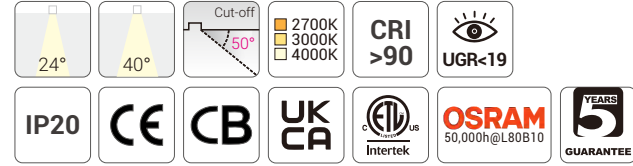

Quick Info

- Ceiling Cut-out: 144x37mm for Trim Version
- OSRAM LED: 11W, CRI>80, CRI>90
- CCT: 2700K, 3000K, 4000K Available as Standard
- Beam Angle: 24°, 40°
- Lumen Output: Up to 750lm System Luminous Flux
- IP Class: IP20
- LED Driver: On-Off, Phase Dim, 1-10V Dim, DALI Dim, Casambi Wireless Dim

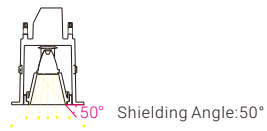
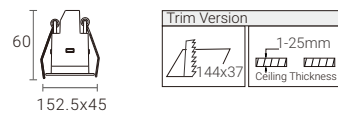

Light Distribution

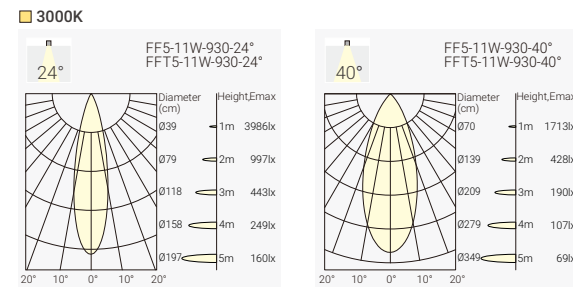

Finish



Order Info (FUSION FF5 in White Trim & Black Reflector as an Example)

LED Power	System Power	LED Voltage	LED Current	CRI	CCT	Beam	LED Output	System Output	Code
11W	13W	15V	700mA	90	2700K	24°	950lm	650lm	FF5-9272411N-WB
					3000K	24°	1050lm	700lm	FF5-9302411N-WB
					4000K	24°	1150lm	750lm	FF5-9402411N-WB
						40°	950lm	650lm	FF5-9274011N-WB
						40°	1050lm	700lm	FF5-9304011N-WB
						40°	1150lm	750lm	FF5-9404011N-WB

Code Remark: N=N(No Driver) F=F(ON-OFF) P=P(Phase Dim) A=A(1-10V Dim) D=D(DALI Dim)

Reflector Options



Coding

Model	CRI/ CCT	Beam Angle	LED Power	Control	Finish	Reflector Color	Accessory
FF5 FUSION FF5	927 CRI>90/ 2700K	24°	11	N No Driver	W White	B Black	
FFT5 FUSION FFT5	930 CRI>90/ 3000K	40°		F On-Off	B Black	S Specular	
	940 CRI>90/ 4000K			P Phase Dim			
				A 1-10V Dim			
				D DALI Dim			

Trimless Version



FFT5

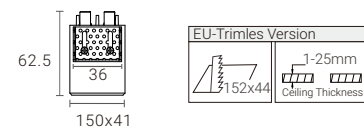

Project: World Health Organization Building, Philippines



FUSION FF10 – Fixed LED Spotlight

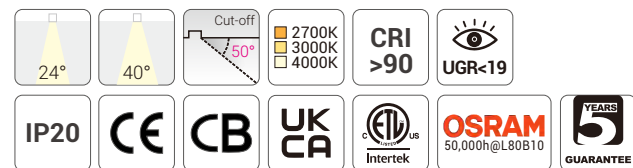

Quick Info

- Ceiling Cut-out: 282x37mm for Trim Version
- OSRAM LED: 22W, CRI>90
- CCT: 2700K, 3000K, 4000K Available as Standard
- Beam Angle: 24°, 40°
- Lumen Output: Up to 1650lm System Luminous Flux
- IP Class: IP20
- LED Driver: On-Off, Phase Dim, 1-10V Dim, DALI Dim, Casambi Wireless Dim

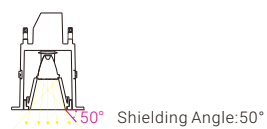
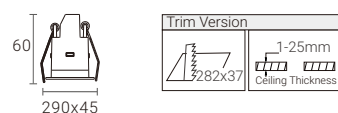

Finish



White



Black

Reflector Options



Specular



Black

Trimless Version

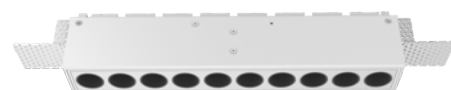

FFT10

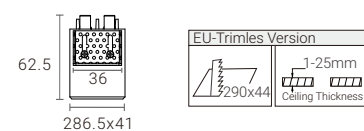

Light Distribution

3000K

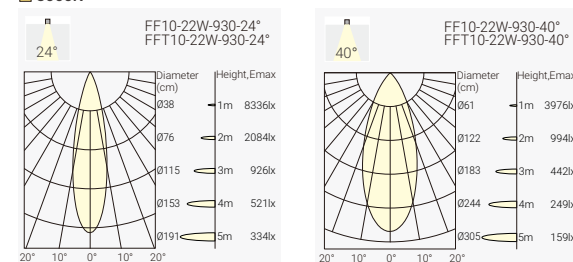

Order Info (FUSION FF10 in White Trim & Black Reflector as an Example)

LED Power	System Power	LED Voltage	LED Current	CRI	CCT	Beam	LED Output	System Output	Code
22 W	24 W	30 V	700 mA	90	2700K	24°	1900lm	1400lm	FF10-9272422N-WB
						40°	1900lm	1400lm	FF10-9274022N-WB
					3000K	24°	2050lm	1500lm	FF10-9302422N-WB
						40°	2050lm	1500lm	FF10-9304022N-WB
					4000K	24°	2200lm	1650lm	FF10-9402422N-WB
						40°	2200lm	1650lm	FF10-9404022N-WB

Code Remark: N=N(No Driver) F=F(ON-OFF) P=P(Phase Dim) A=A(1-10V Dim) D=D(DALI Dim)

Coding

Model	CRI/ CCT	Beam Angle	LED Power	Control	Finish	Reflector Color	Accessory
FF10 FUSION FF10	927 CRI>90/ 2700K	24°	22	N No Driver	W White	B Black	
FFTA FUSION FFT10	930 CRI>90/ 3000K	40°		F On-Off	B Black	S Specular	
	940 CRI>90/ 4000K			P Phase Dim			
				A 1-10V Dim			
				D DALI Dim			

Project: Bvlgari Hotel, Shanghai, China

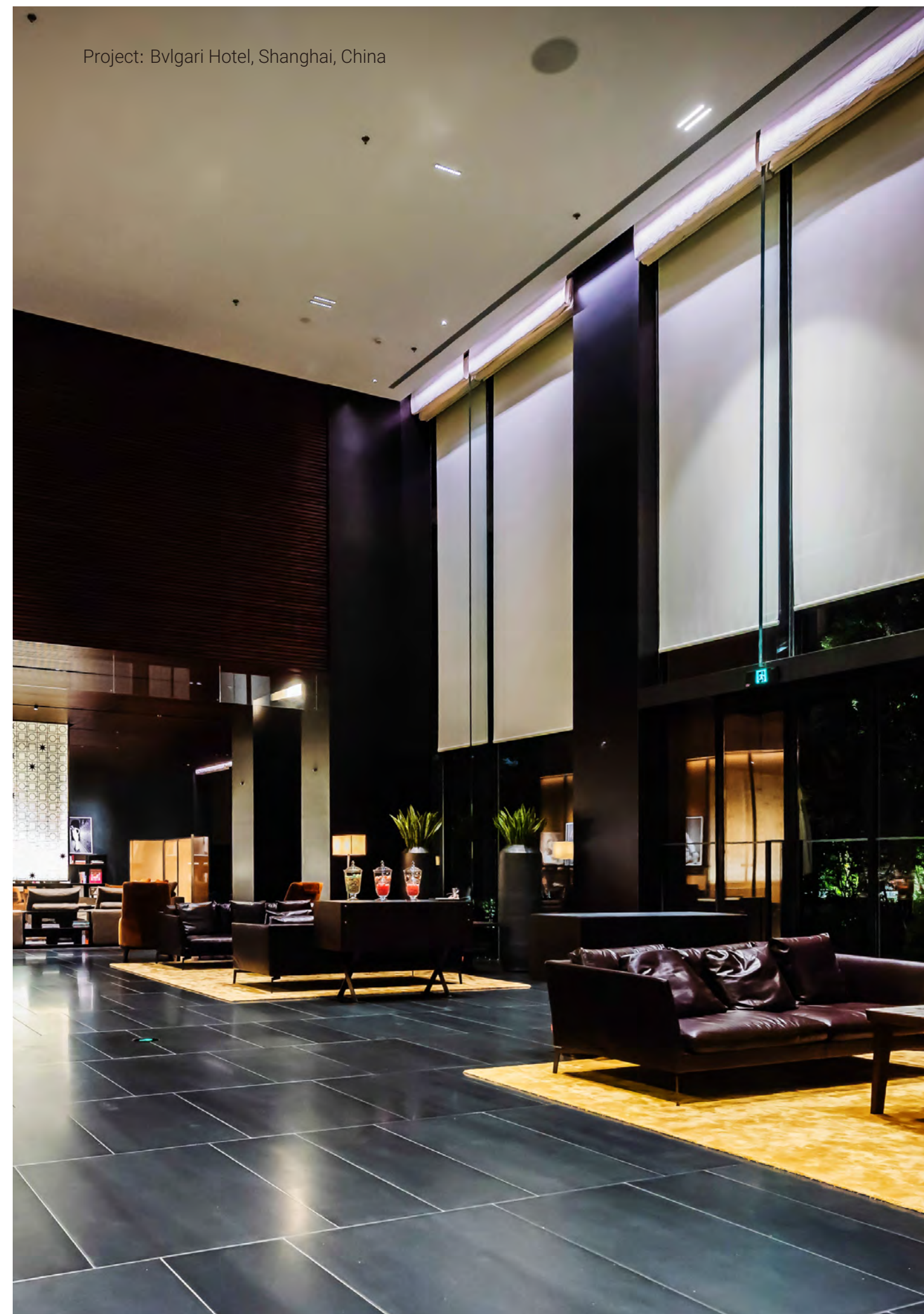

FUSION FF2-IP65 – Surface IP65 FUSION Downlight

NEW



Quick Info

- Ceiling Cut-out: 66x37mm
- OSRAM LED: 4W, CRI>90
- CCT: 2700K, 3000K, 4000K Available as Standard
- Beam Angle: 35°, 45°
- Lumen Output: Up to 270lm System Luminous Flux
- IP Class: IP65 from Front
- LED Driver: On-Off, Phase Dim, 1-10V Dim, DALI Dim

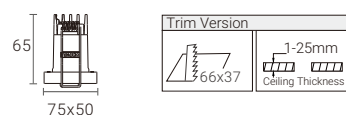

Light Distribution

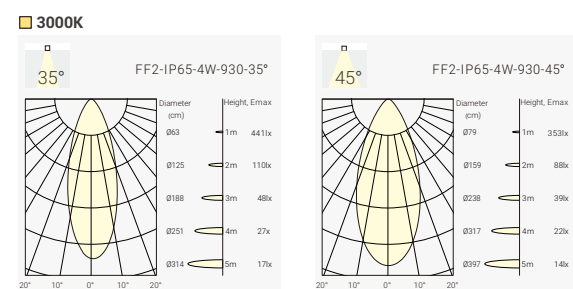

Finish



Order Info (FUSION FF2-IP65 in White Housing & Black Reflector as an Example)

LED Power	System Power	LED Voltage	LED Current	CRI	CCT	Beam	LED Output	System Output	Code
4W	6W	6V	700mA	90	2700K	35°	400lm	240lm	FF2-9273504N-WB-IP
						45°	400lm	205lm	FF2-9274504N-WB-IP
					3000K	35°	450lm	250lm	FF2-9303504N-WB-IP
						45°	450lm	215lm	FF2-9304504N-WB-IP
					4000K	35°	500lm	270lm	FF2-9403504N-WB-IP
						45°	500lm	230lm	FF2-9404504N-WB-IP

Code Remark: N=N(No Driver) F=F(ON-OFF) P=P(Phase Dim) A=A(1-10V Dim) D=D(DALI Dim)

Coding

Model	CRI/ CCT	Beam Angle	LED Power	Control	Finish	Reflector Color	Accessory
FF2	927	35	04	N	W	B	IP
FF2-IP65	CRI>90/ 2700K	35°	4W	No Driver	White	Black	IP65
	930	45		F	B		
	CRI>90/ 3000K	45°		On-Off	Black		
	940			P			
	CRI>90/ 4000K			Phase Dim			
				A			
				1-10V Dim			
				D			
				DALI Dim			

FUSION FF3-IP65 – Surface IP65 FUSION Downlight

NEW



Quick Info

- Ceiling Cut-out: 90x37mm
- OSRAM LED: 7W, CRI>90
- CCT: 2700K, 3000K, 4000K Available as Standard
- Beam Angle: 35°, 45°
- Lumen Output: Up to 410lm System Luminous Flux
- IP Class: IP65 from Front
- LED Driver: On-Off, Phase Dim, 1-10V Dim, DALI Dim

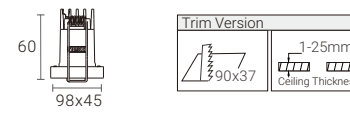

Light Distribution

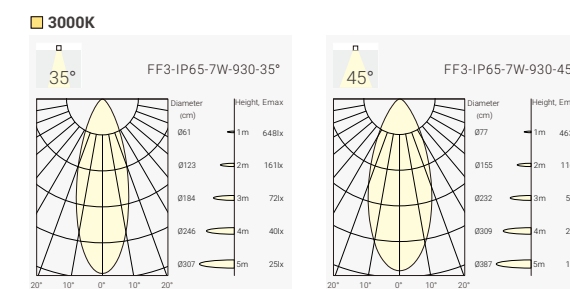

Finish

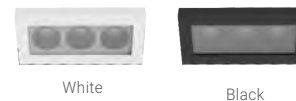

Order Info (FUSION FF3-IP65 in White Housing & Black Reflector as an Example)

LED Power	System Power	LED Voltage	LED Current	CRI	CCT	Beam	LED Output	System Output	Code
7W	9W	9V	700mA	90	2700K	35°	600lm	360lm	FF3-9273507N-WB-IP
						45°	600lm	315lm	FF3-9274507N-WB-IP
					3000K	35°	650lm	385lm	FF3-9303507N-WB-IP
						45°	650lm	335lm	FF3-9304507N-WB-IP
					4000K	35°	700lm	410lm	FF3-9403507N-WB-IP
						45°	700lm	350lm	FF3-9404507N-WB-IP

Code Remark: N=N(No Driver) F=F(ON-OFF) P=P(Phase Dim) A=A(1-10V Dim) D=D(DALI Dim)

Coding

Model	CRI/ CCT	Beam Angle	LED Power	Control	Finish	Reflector Color	Accessory
FF3	927	35	07	N	W	B	IP
FF3-IP65	CRI>90/ 2700K	35°	7W	No Driver	White	Black	IP65
	930	45		F	B		
	CRI>90/ 3000K	45°		On-Off	Black		
	940			P			
	CRI>90/ 4000K			Phase Dim			
				A			
				1-10V Dim			
				D			
				DALI Dim			

FUSION FF5-IP65 – Surface IP65 FUSION Downlight

NEW



Quick Info

- Ceiling Cut-out: 148x37mm
- OSRAM LED: 11W, CRI>90
- CCT: 2700K, 3000K, 4000K Available as Standard
- Beam Angle: 35°, 45°
- Lumen Output: Up to 840lm System Luminous Flux
- IP Class: IP65 from Front
- LED Driver: On-Off, Phase Dim, 1-10V Dim, DALI Dim, Casambi Wireless Dim

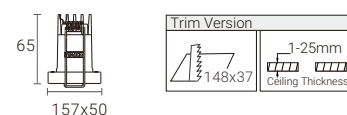

Light Distribution

3000K

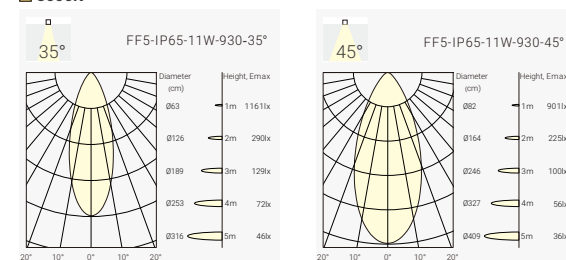

Finish

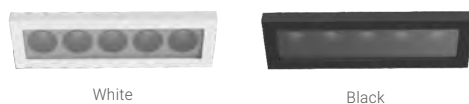

Order Info (FUSION FF5-IP65 in White Housing & Black Reflector as an Example)

LED Power	System Power	LED Voltage	LED Current	CRI	CCT	Beam	LED Output	System Output	Code
11W	13W	15V	700mA	90	2700K	35°	950lm	745lm	FF5-9273511N-WB-IP
						45°	950lm	620lm	FF5-9274511N-WB-IP
					3000K	35°	1050lm	785lm	FF5-9303511N-WB-IP
						45°	1050lm	650lm	FF5-9304511N-WB-IP
					4000K	35°	1150lm	840lm	FF5-9403511N-WB-IP
						45°	1150lm	700lm	FF5-9404511N-WB-IP

Code Remark: N=N(No Driver) F=F(ON-OFF) P=P(Phase Dim) A=A(1-10V Dim) D=D(DALI Dim)

Coding

Model	CRI/ CCT	Beam Angle	LED Power	Control	Finish	Reflector Color	Accessory
FF5	927	35	11	N	W	B	IP
FF5-IP65	CRI>90/ 2700K	35°	11W	No Driver	White	Black	IP65
	930	45		F	B		
	CRI>90/ 3000K	45°		On-Off	Black		
	940			P			
	CRI>90/ 4000K			Phase Dim			
				A			
				1-10V Dim			
				D			
				DALI Dim			

FUSION FF10-IP65 – Surface IP65 FUSION Downlight

NEW



Quick Info

- Ceiling Cut-out: 286x37mm
- OSRAM LED: 22W, CRI>90
- CCT: 2700K, 3000K, 4000K Available as Standard
- Beam Angle: 35°, 40°
- Lumen Output: Up to 1400lm System Luminous Flux
- IP Class: IP65 from Front
- LED Driver: On-Off, Phase Dim, 1-10V Dim, DALI Dim, Casambi Wireless Dim

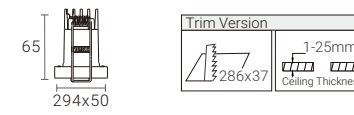

Light Distribution

3000K

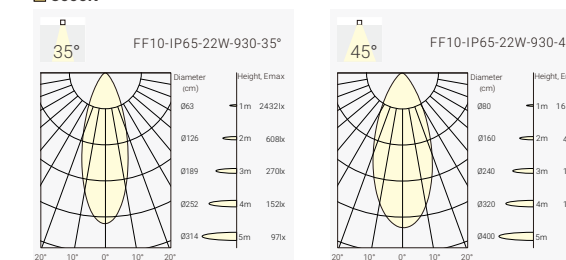

Finish

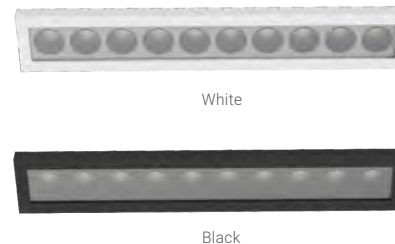

Order Info (FUSION FF10-IP65 in White Housing & Black Reflector as an Example)

LED Power	System Power	LED Voltage	LED Current	CRI	CCT	Beam	LED Output	System Output	Code
22W	24W	30V	700mA	90	2700K	35°	1900lm	1250lm	FF10-9272422N-WB-IP
						45°	1900lm	1200lm	FF10-9274022N-WB-IP
					3000K	35°	2050lm	1300lm	FF10-9302422N-WB-IP
						45°	2050lm	1250lm	FF10-9304022N-WB-IP
					4000K	35°	2200lm	1400lm	FF10-9402422N-WB-IP
						45°	2200lm	1300lm	FF10-9404022N-WB-IP

Code Remark: N=N(No Driver) F=F(ON-OFF) P=P(Phase Dim) A=A(1-10V Dim) D=D(DALI Dim)

Coding

Model	CRI/ CCT	Beam Angle	LED Power	Control	Finish	Reflector Color	Accessory
FF10	927	35	22	N	W	B	IP
FF10-IP65	CRI>90/ 2700K	35°	22W	No Driver	White	Black	IP65
	930	45		F	B		
	CRI>90/ 3000K	45°		On-Off	Black		
	940			P			
	CRI>90/ 4000K			Phase Dim			
				A			
				1-10V Dim			
				D			
				DALI Dim			

FUSION FA5 – Adjustable LED Downlight

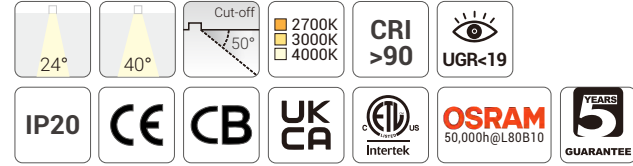

Quick Info

- Ceiling Cut-out: 160x53mm for Trim Version
- OSRAM LED: 11W, CRI>90
- CCT: 2700K, 3000K, 4000K Available as Standard
- Beam Angle: 24°, 40°
- Lumen Output: Up to 750lm System Luminous Flux
- IP Class: IP20
- LED Driver: On-Off, Phase Dim, 1-10V Dim, DALI Dim, Casambi Wireless Dim

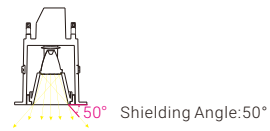
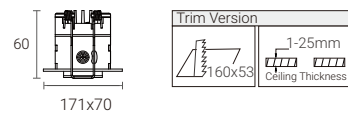

Light Distribution

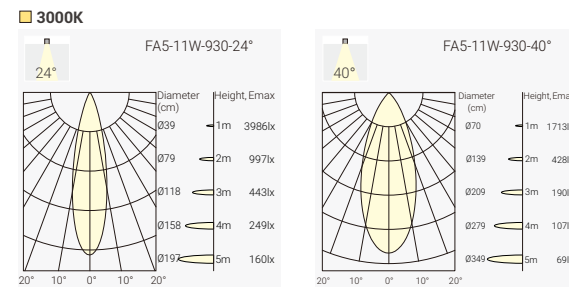

Finish



White Black

Reflector Options



Black Specular

Order Info (FUSION FA5 in White Trim & Black Reflector as an Example)

LED Power	System Power	LED Voltage	LED Current	CRI	CCT	Beam	LED Output	System Output	Code
11W	13 W	15V	700mA	90	2700K	24°	950lm	650lm	FA5-9272411N-WB
						40°	950lm	650lm	FA5-9274011N-WB
						24°	1050lm	700lm	FA5-9302411N-WB
						40°	1050lm	700lm	FA5-9304011N-WB
						24°	1150lm	750lm	FA5-9402411N-WB
						40°	1150lm	750lm	FA5-9404011N-WB

Code Remark: N=N(No Driver) F=F(ON-OFF) P=P(Phase Dim) A=A(1-10V Dim) D=D(DALI Dim)

Coding

Model	CRI/ CCT	Beam Angle	LED Power	Control	Finish	Reflector Color	Accessory
FA5	927	24	11	N	W	B	
FUSION FA5	CRI>90/ 2700K	24°	11W	No Driver	White	Black	
	930	40		F	B	S	
	CRI>90/ 3000K	40°		On-Off	Black	Specular	
	940			P			
	CRI>90/ 4000K			Phase Dim			
				A			
				1-10V Dim			
				D			
				DALI Dim			

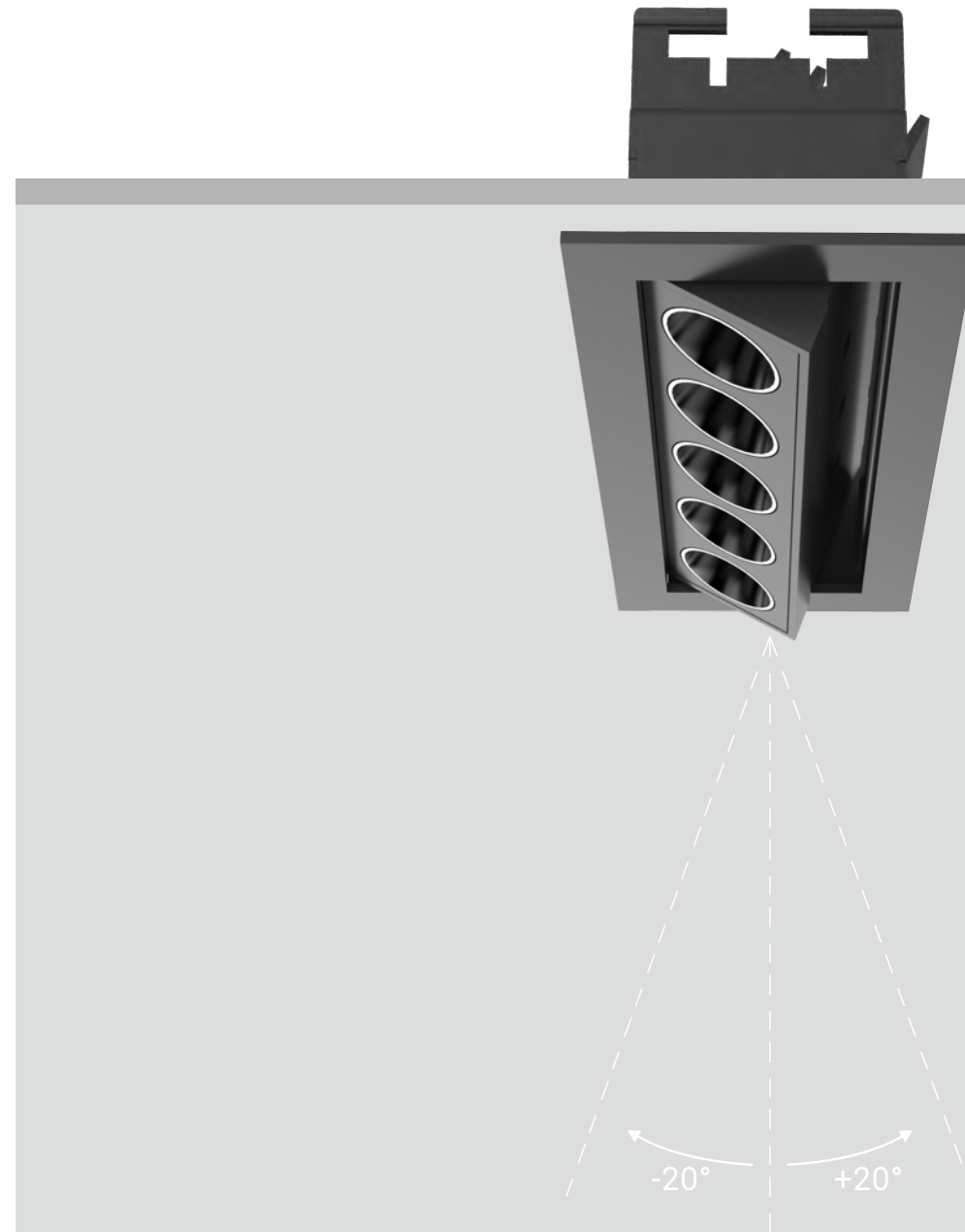

FUSION FA10 – Adjustable LED Downlight

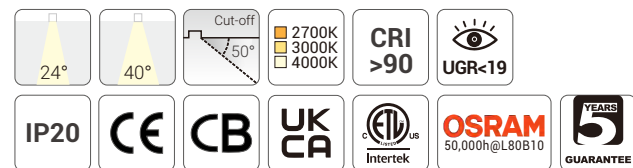

Quick Info

- Ceiling Cut-out: 198x53mm for Trim Version
- OSRAM LED: 22W, CRI>90
- CCT: 2700K, 3000K, 4000K Available as Standard
- Beam Angle: 24°, 40°
- Lumen Output: Up to 1650lm System Luminous Flux
- IP Class: IP20
- LED Driver: On-Off, Phase Dim, 1-10V Dim, DALI Dim, Casambi Wireless Dim

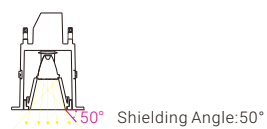
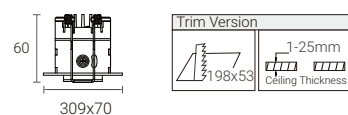

Light Distribution

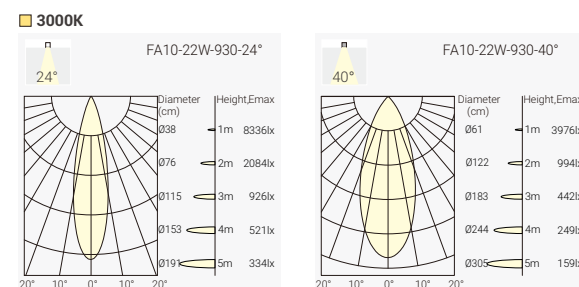

Finish



White



Black

Reflector Options



Black



Specular

Order Info (FUSION FFA10 in White Trim & Black Reflector as an Example)

LED Power	System Power	LED Voltage	LED Current	CRI	CCT	Beam	LED Output	System Output	Code		
22W	24W	30V	700mA	90	2700K	24°	1900lm	1400lm	FA10-9272422N-WB		
						40°	1900lm	1400lm	FA10-9274022N-WB		
						3000K	24°	2050lm	1500lm	FA10-9302422N-WB	
							40°	2050lm	1500lm	FA10-9304022N-WB	
							4000K	24°	2200lm	1650lm	FA10-9402422N-WB
								40°	2200lm	1650lm	FA10-9404022N-WB

Code Remark: N=N(No Driver) F=F(ON-OFF) P=P(Phase Dim) A=A(1-10V Dim) D=D(DALI Dim)

Coding

Model	CRI/ CCT	Beam Angle	LED Power	Control	Finish	Reflector Color	Accessory
FA10	927	24	22	N	W	B	
FUSION FA10	CRI>90/ 2700K	24°	22W	No Driver	White	Black	
	930	40		F	B	S	
	CRI>90/ 3000K	40°		On-Off	Black	Specular	
	940			P			
	CRI>90/ 4000K			Phase Dim			
				A			
				1-10V Dim			
				D			
				DALI Dim			

Project: Bvlgari Hotel, Shanghai, China



FUSION FW5 – Wall Washer LED Downlight



Quick Info

- Ceiling Cut-out: 144x37mm for Trim Version
- OSRAM LED: 11W, CRI>90
- CCT: 2700K, 3000K, 4000K Available as Standard
- Beam Angle: Wall Washer
- Lumen Output: Up to 550lm System Luminous Flux
- IP Class: IP20
- LED Driver: On-Off, Phase Dim, 1-10V Dim, DALI Dim, Casambi Wireless Dim

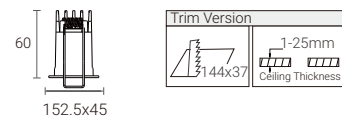

Light Distribution

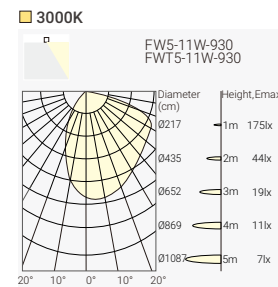

Finish



Order Info (FUSION FW5 in White Trim & Matt Reflector as an Example)

LED Power	System Power	LED Voltage	LED Current	CRI	CCT	Beam	LED Output	System Output	Code
11W	13W	15V	700mA	90	2700K	WW	900lm	450lm	FW5-927WW11N-WM
					3000K	WW	950lm	500lm	FW5-930WW11N-WM
					4000K	WW	1050lm	550lm	FW5-940WW11N-WM

Code Remark: N=N(No Driver) F=F(ON-OFF) P=P(Phase Dim) A=A(1-10V Dim) D=D(DALI Dim)

Trimless Version



FWT5

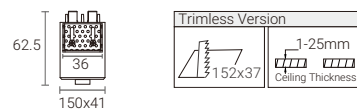

Coding

Model	CRI/ CCT	Beam Angle	LED Power	Control	Finish	Reflector Color	Accessory
FW5 FUSION FW5	927 CRI>90/ 2700K	WW Wall Washer	11 11W	N No Driver	W White	M Matt	
FWT5 FUSION FWT5	930 CRI>90/ 3000K			F On-Off	B Black		
	940 CRI>90/ 4000K			P Phase Dim			
				A 1-10V Dim			
				D DALI Dim			

Project: Oslo Hall, City Hall Gallery, Norway

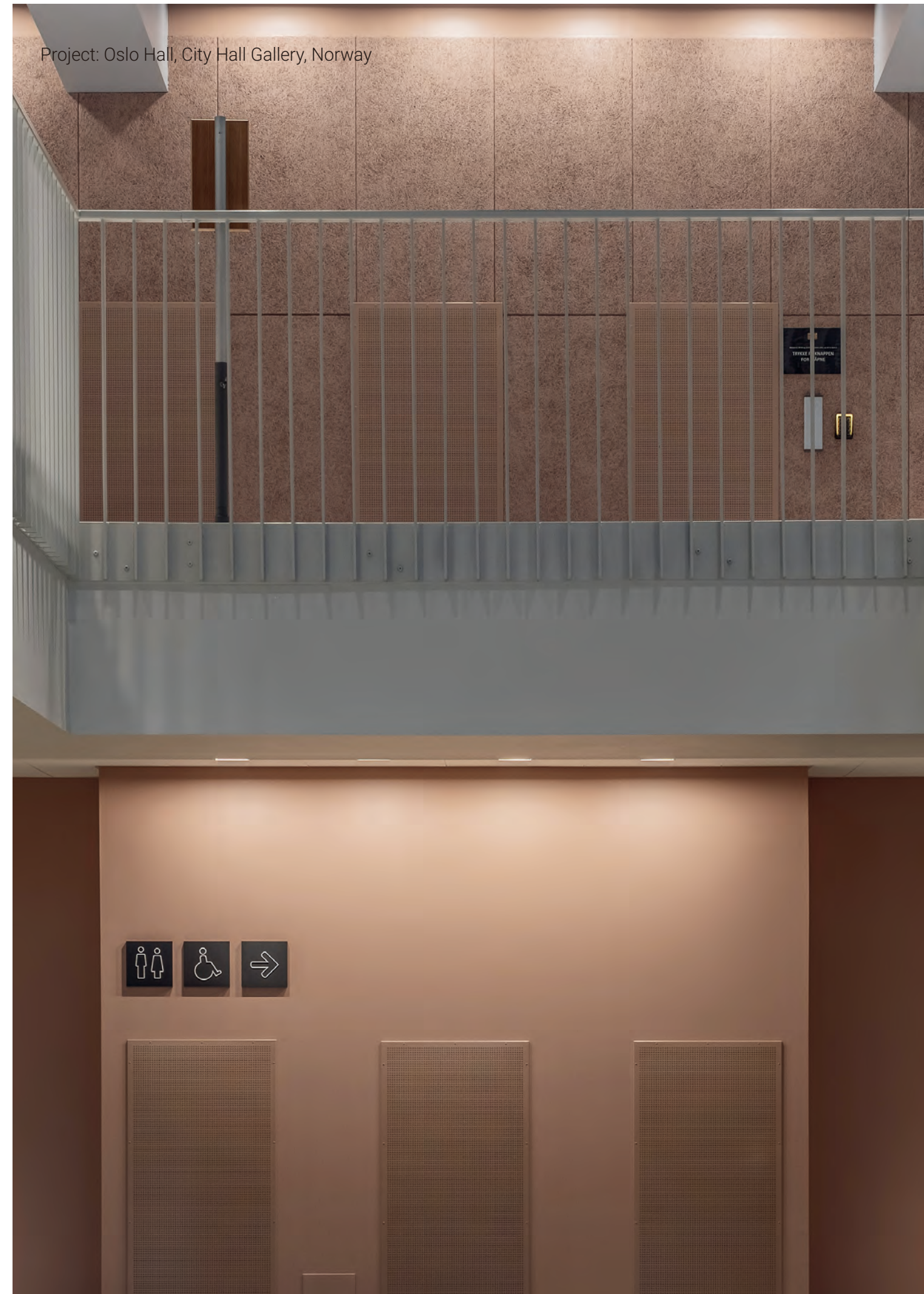

FUSION FW10 – Wall Washer LED Downlight



Quick Info

- Ceiling Cut-out: 282x37mm for Trim Version
- OSRAM LED: 22W, CRI>90
- CCT: 2700K, 3000K, 4000K Available as Standard
- Beam Angle: Wall Washer
- Lumen Output: Up to 1200lm System Luminous Flux
- IP Class: IP20
- LED Driver: On-Off, Phase Dim, 1-10V Dim, DALI Dim, Casambi Wireless Dim

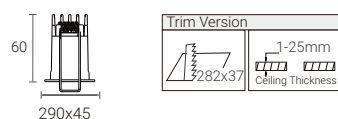

Light Distribution

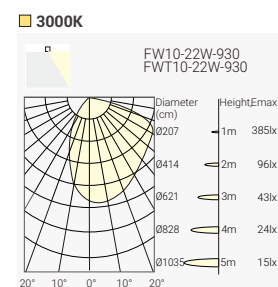

Finish



Order Info (FUSION FW10 in White Trim & Black Reflector as an Example)

LED Power	System Power	LED Voltage	LED Current	CRI	CCT	Beam	LED Output	System Output	Code
22W	24W	30V	700mA	90	2700K	WW	2000lm	1000lm	FW10-927WW22N-WM
					3000K	WW	2200lm	1100lm	FW10-930WW22N-WM
					4000K	WW	2400lm	1200lm	FW10-940WW22N-WM

Code Remark: N=N(No Driver) F=F(ON-OFF) P=P(Phase Dim) A=A(1-10V Dim) D=D(DALI Dim)

Trimless Version

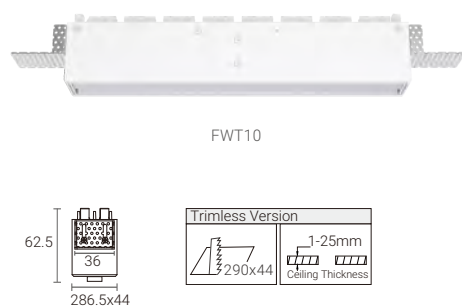

Coding

Model	CRI/ CCT	Beam Angle	LED Power	Control	Finish	Reflector Color	Accessory
FW10 FUSION FW10	927 CRI>90/ 2700K	WW Wall Washer	22 22W	N No Driver	W White	M Matt	
FWTA FUSION FWTA	930 CRI>90/ 3000K			F On-Off	B Black		
	940 CRI>90/ 4000K			P Phase Dim			
				A 1-10V Dim			
				D DALI Dim			

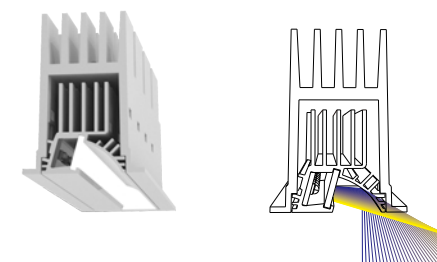

High quality wall washer illumination

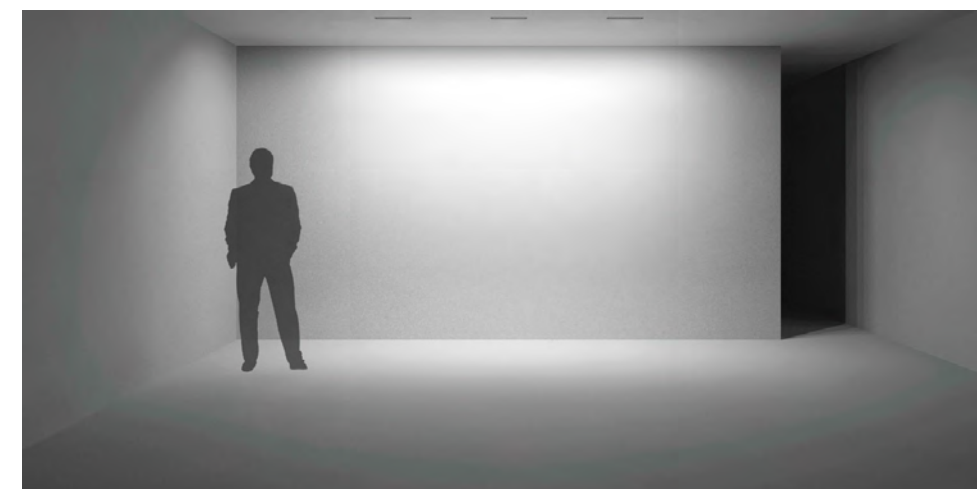

FUSION FG5 – General LED Downlight



Quick Info

- Ceiling Cut-out: 144x37mm for Trim Version
- OSRAM LED: 11W, CRI>80, CRI>90
- CCT: 2700K, 3000K, 4000K Available as Standard
- Beam Angle: 75°
- Lumen Output: Up to 400lm System Luminous Flux
- IP Class: IP20
- LED Driver: On-Off, Phase Dim, 1-10V Dim, DALI Dim, Casambi Wireless Dim

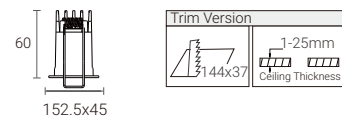

Light Distribution

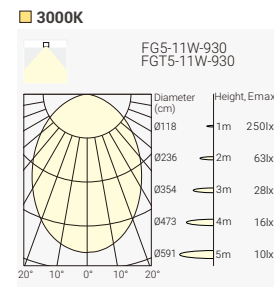

Finish



Order Info (FUSION FG5 in White Trim & Black Reflector as an Example)

LED Power	System Power	LED Voltage	LED Current	CRI	CCT	Beam	LED Output	System Output	Code
11W	13W	15V	700mA	90	2700K	75°	900lm	330lm	FG5-9277511N-WB
					3000K	75°	950lm	350lm	FG5-9277511N-WB
					4000K	75°	1050lm	400lm	FG5-9307511N-WB

Code Remark: N=N(No Driver) F=F(ON-OFF) P=P(Phase Dim) A=A(1-10V Dim) D=D(DALI Dim)

Coding

FG5 - *** ** ** * - * * - *

Model	CRI/ CCT	Beam Angle	LED Power	Control	Finish	Reflector Color	Accessory
FG5 FUSION FG5	927 CRI>90/ 2700K	75 75°	11 11W	N No Driver	W White	B Black	
FGT5 FUSION FGT5	930 CRI>90/ 3000K			F On-Off	B Black		
	940 CRI>90/ 4000K			P Phase Dim			
				A 1-10V Dim			
				D DALI Dim			

Trimless Version

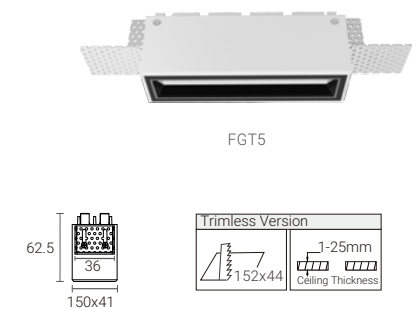

FUSION FG10 – General LED Downlight



Quick Info

- Ceiling Cut-out: Ø55mm for Trim Version
- OSRAM LED: 22W, CRI>90
- CCT: 2700K, 3000K, 4000K Available as Standard
- Beam Angle: 75°
- Lumen Output: Up to 850lm System Luminous Flux
- IP Class: IP20
- LED Driver: On-Off, Phase Dim, 1-10V Dim, DALI Dim, Casambi Wireless Dim

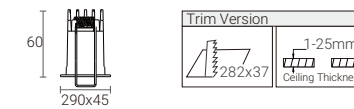

Light Distribution

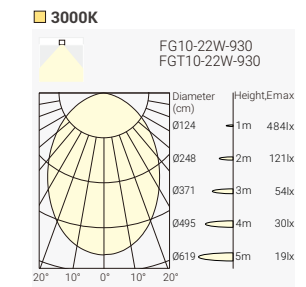

Finish

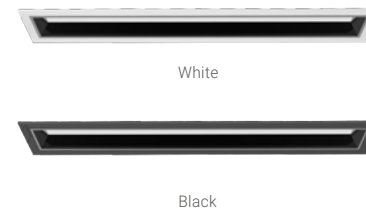

Order Info (FUSION FG10 in White Trim & Black Reflector as an Example)

LED Power	System Power	LED Voltage	LED Current	CRI	CCT	Beam	LED Output	System Output	Code
22W	24W	30V	700mA	90	2700K	75°	2000lm	750lm	FG10-9277522N-WB
					3000K	75°	2200lm	800lm	FG10-9307522N-WB
					4000K	75°	2400lm	850lm	FG10-9407522N-WB

Code Remark: N=N(No Driver) F=F(ON-OFF) P=P(Phase Dim) A=A(1-10V Dim) D=D(DALI Dim)

Trimless Version

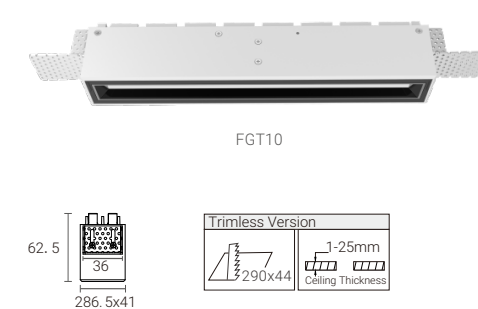

Coding

FG10 - *** ** ** * - * * - *

Model	CRI/ CCT	Beam Angle	LED Power	Control	Finish	Reflector Color	Accessory
FG10 FUSION FG10	927 CRI>90/ 2700K	75 75°	22 22W	N No Driver	W White	B Black	
FGTA FUSION FGT10	930 CRI>90/ 3000K			F On-Off	B Black		
	940 CRI>90/ 4000K			P Phase Dim			
				A 1-10V Dim			
				D DALI Dim			



Diversity Design with Adjustable Spot Light



FUSION FS1 – Adjustable Spotlight



Quick Info

- Ceiling Cut-out: 62x37mm
- OSRAM LED: 2W, CRI>90
- CCT: 2700K, 3000K, 4000K Available as Standard
- Beam Angle: 15°, 30°
- Lumen Output: Up to 160lm System Luminous Flux
- IP Class: IP20
- LED Driver: On-Off, No-Off, 1-10V Dim, DALI Dim

Light Distribution

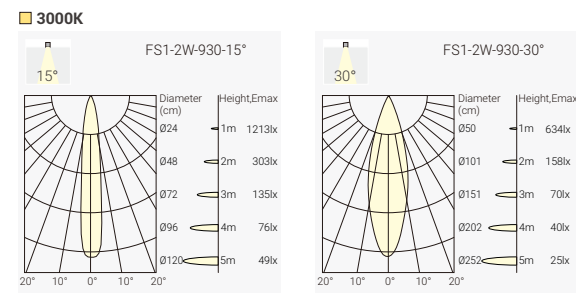
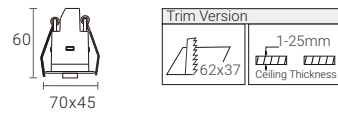

Finish



Order Info (FUSION FS1 in White Finish as an Example)

LED Power	System Power	LED Voltage	LED Current	CRI	CCT	Beam	LED Output	System Output	Code
2W	3W	3V	700mA	90	2700K	15°	200lm	130lm	FS1-9271502N-WN
					3000K	15°	200lm	130lm	FS1-9273002N-WN
					3000K	30°	210lm	140lm	FS1-9301502N-WN
					4000K	15°	210lm	140lm	FS1-9303002N-WN
					4000K	30°	230lm	160lm	FS1-9401502N-WN
					4000K	30°	230lm	160lm	FS1-9403002N-WN

Code Remark: N=N(No Driver) F=F(ON-OFF) A=A(1-10V Dim) D=D(DALI Dim)

Coding

Model	CRI/ CCT	Beam Angle	LED Power	Control	Finish	Reflector Color	Accessory
FS1	927	15	02	N	W	N	
FUSION FS1	CRI>90/ 2700K	15°	2W	No Driver	White	None	
	930	30		F	B		
	CRI>90/ 3000K	30°		On-Off	Black		
	940			A			
	CRI>90/ 4000K			1-10V Dim			
				D			
				DALI Dim			

*In same BRIDGELUX LED chip as FUSION G2 series is optional.

FUSION FS2 – Adjustable Spotlight



Quick Info

- Ceiling Cut-out: 90x37mm
- OSRAM LED: 4W, CRI>90
- CCT: 2700K, 3000K, 4000K Available as Standard
- Beam Angle: 15°, 30°
- Lumen Output: Up to 330lm System Luminous Flux
- IP Class: IP20
- LED Driver: On-Off, Phase Dim, 1-10V Dim, DALI Dim

Light Distribution

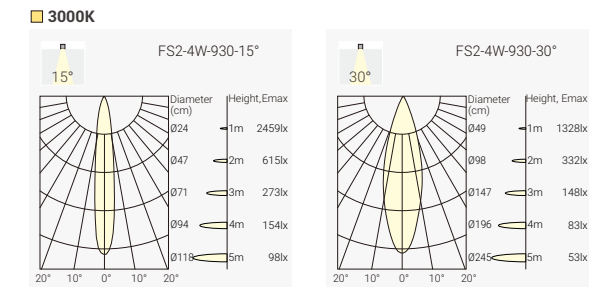
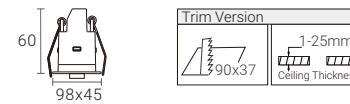

Finish



Order Info (FUSION FS2 in White Finish as an Example)

LED Power	System Power	LED Voltage	LED Current	CRI	CCT	Beam	LED Output	System Output	Code
4W	6W	6V	700mA	90	2700K	15°	400lm	280lm	FS2-9271504N-WN
					3000K	15°	400lm	280lm	FS2-9273004N-WN
					3000K	30°	450lm	300lm	FS2-9301504N-WN
					4000K	15°	450lm	300lm	FS2-9303004N-WN
					4000K	30°	500lm	330lm	FS2-9401504N-WN
					4000K	30°	500lm	330lm	FS2-9403004N-WN

Code Remark: N=N(No Driver) F=F(ON-OFF) P=P(Phase Dim) A=A(1-10V Dim) D=D(DALI Dim)

Coding

Model	CRI/ CCT	Beam Angle	LED Power	Control	Finish	Reflector Color	Accessory
FS2	927	15	04	N	W	N	
FUSION FS2	CRI>90/ 2700K	15°	4W	No Driver	White	None	
	930	30		F	B		
	CRI>90/ 3000K	30°		On-Off	Black		
	940			P			
	CRI>90/ 4000K			Phase Dim			
				A			
				1-10V Dim			
				D			
				DALI Dim			

*In same BRIDGELUX LED chip as FUSION G2 series is optional.

FUSION FS3 – Adjustable Spotlight



Quick Info

- Ceiling Cut-out: 144x37mm for Trim Version
- OSRAM LED: 7W, CRI>90
- CCT: 2700K, 3000K, 4000K Available as Standard
- Beam Angle: 15°, 30°
- Lumen Output: Up to 500lm System Luminous Flux
- IP Class: IP20
- LED Driver: On-Off, Phase Dim, 1-10V Dim, DALI Dim

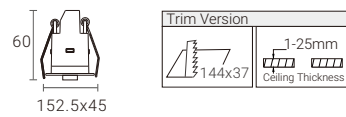

Light Distribution

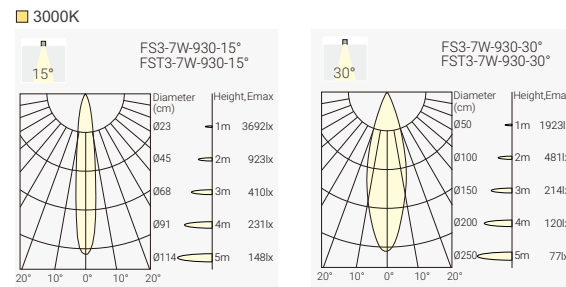

Finish



Order Info (FUSION FS3 in White Finish as an Example)

LED Power	System Power	LED Voltage	LED Current	CRI	CCT	Beam	LED Output	System Output	Code
7W	9W	9V	700mA	90	2700K	15°	600lm	420lm	FS3-9271507N-WN
						30°	600lm	420lm	FS3-9273007N-WN
					3000K	15°	650lm	450lm	FS3-9301507N-WN
						30°	650lm	450lm	FS3-9303007N-WN
					4000K	15°	700lm	500lm	FS3-9401507N-WN
						30°	700lm	500lm	FS3-9403007N-WN

Code Remark: N=N(No Driver) F=F(ON-OFF) P=P(Phase Dim) A=A(1-10V Dim) D=D(DALI Dim)

Coding

Model	CRI/ CCT	Beam Angle	LED Power	Control	Finish	Reflector Color	Accessory
FS3 FUSION FS3	927 CRI>90/ 2700K	15°	07 7W	N No Driver	W White	N None	
FST3 FUSION FST3	930 CRI>90/ 3000K	30°		F On-Off	B Black		
	940 CRI>90/ 4000K			P Phase Dim			
				A 1-10V Dim			
				D DALI Dim			

*In same BRIDGELUX LED chip as FUSION G2 series is optional.

Trimless Version

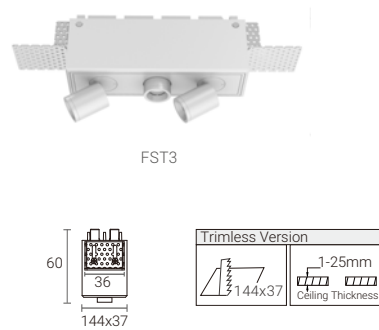

FUSION FS6 – Adjustable Spotlight



Quick Info

- Ceiling Cut-out: 282x37mm for Trim Version
- OSRAM LED: 13W, CRI>90
- CCT: 2700K, 3000K, 4000K Available as Standard
- Beam Angle: 15°, 30°
- Lumen Output: Up to 900lm System Luminous Flux
- IP Class: IP20
- LED Driver: On-Off, Phase Dim, 1-10V Dim, DALI Dim, Casambi Wireless Dim

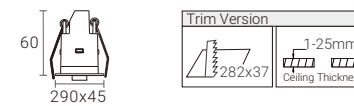

Light Distribution

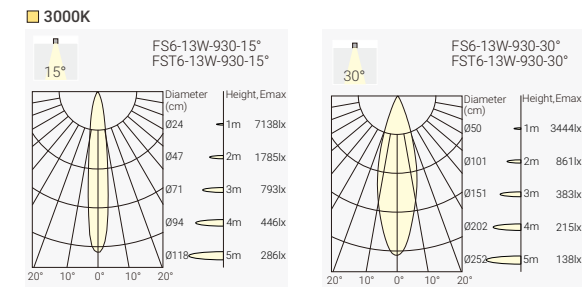

Finish

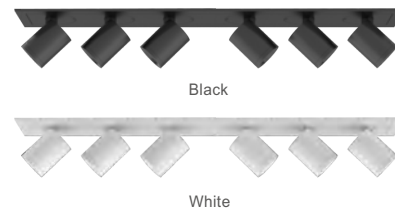

Order Info (FUSION FS6 in White Finish as an Example)

LED Power	System Power	LED Voltage	LED Current	CRI	CCT	Beam	LED Output	System Output	Code
13W	15W	18V	700mA	90	2700K	15°	1200lm	800lm	FS6-9271513N-WN
						30°	1200lm	800lm	FS6-9273013N-WN
					3000K	15°	1300lm	850lm	FS6-9301513N-WN
						30°	1300lm	850lm	FS6-9303013N-WN
					4000K	15°	1400lm	900lm	FS6-9401513N-WN
						30°	1400lm	900lm	FS6-9403013N-WN

Code Remark: N=N(No Driver) F=F(ON-OFF) P=P(Phase Dim) A=A(1-10V Dim) D=D(DALI Dim)

Trimless Version

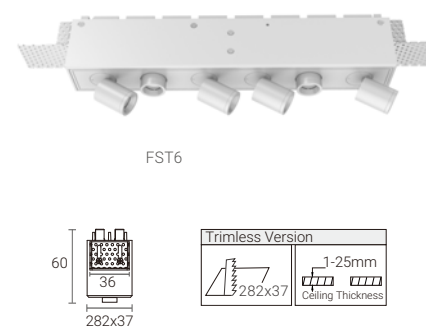

Coding

Model	CRI/ CCT	Beam Angle	LED Power	Control	Finish	Reflector Color	Accessory
FS6 FUSION FS6	927 CRI>90/ 2700K	15°	22 22W	N No Driver	W White	N None	
FST6 FUSION FST6	930 CRI>90/ 3000K	30°		F On-Off	B Black		
	940 CRI>90/ 4000K			P Phase Dim			
				A 1-10V Dim			
				D DALI Dim			

*In same BRIDGELUX LED chip as FUSION G2 series is optional.

FUSION FF3-FS3 – Adjustable Spotlight



Quick Info

- Ceiling Cut-out: 144x37mm for Trim Version
- OSRAM LED: 9W, CRI>90
- CCT: 2700K, 3000K, 4000K Available as Standard
- Beam Angle: 24°, 40°
- Lumen Output: Up to 600lm System Luminous Flux
- IP Class: IP20
- LED Driver: On-Off, Phase Dim, 1-10V Dim, DALI Dim, Casambi Wireless Dim

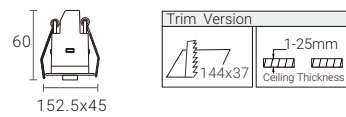

Light Distribution

3000K

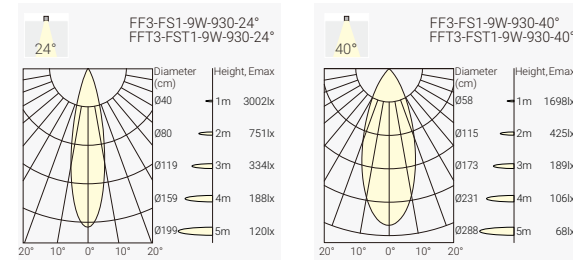

Finish

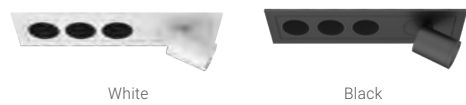

Order Info (FUSION FFS1 in White Finish as an Example)

LED Power	System Power	LED Voltage	LED Current	CRI	CCT	Beam	LED Output	System Output	Code
9W	11W	12 V	700mA	90	2700K	24°	750lm	500lm	FFS1-9272409N-WB
						40°	750lm	500lm	FFS1-9274009N-WB
					3000K	24°	800lm	550lm	FFS1-9302409N-WB
						40°	800lm	550lm	FFS1-9304009N-WB
					4000K	24°	900lm	600lm	FFS1-9402409N-WB
						40°	900lm	600lm	FFS1-9404009N-WB

Code Remark: N=N(No Driver) F=F(ON-OFF) P=P(Phase Dim) A=A(1-10V Dim) D=D(DALI Dim)

Coding

Model	CRI/ CCT	Beam Angle	LED Power	Control	Finish	Reflector Color	Accessory
FFS1 FUSION FFS1	927 CRI>90/ 2700K	24°	09 9W	N No Driver	W White	N None	
FFS3 FUSION FFS3	930 CRI>90/ 3000K	40°		F On-Off	B Black		
	940 CRI>90/ 4000K			P Phase Dim			
				A 1-10V Dim			
				D DALI Dim			

*In same BRIDGELUX LED chip as FUSION G2 series is optional.

Trimless Version

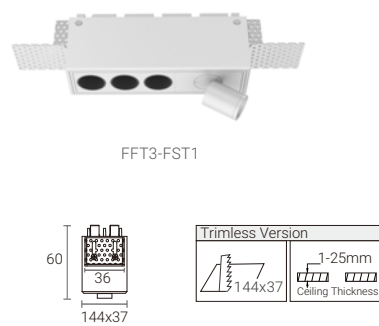

FUSION FF6-FS2 – Adjustable Spotlight



Quick Info

- Ceiling Cut-out: 282x37mm for Trim Version
- OSRAM LED: 17W, CRI>90
- CCT: 2700K, 3000K, 4000K Available as Standard
- Beam Angle: 24°, 40°
- Lumen Output: Up to 1200lm System Luminous Flux
- IP Class: IP20
- LED Driver: On-Off, Phase Dim, 1-10V Dim, DALI Dim, Casambi Wireless Dim

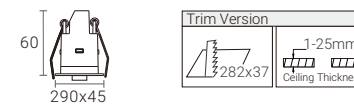

Light Distribution

3000K

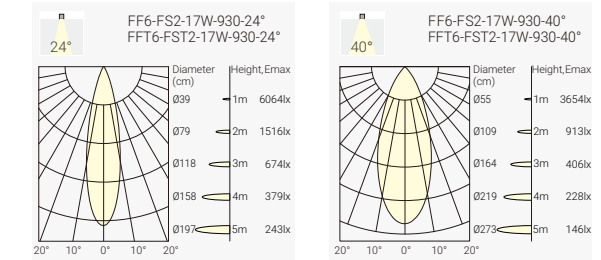

Finish

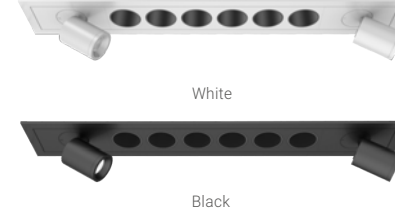

Order Info (FUSION FFS2 in White Finish as an Example)

LED Power	System Power	LED Voltage	LED Current	CRI	CCT	Beam	LED Output	System Output	Code
17W	19W	24 V	700mA	90	2700K	24°	1500lm	1050lm	FFS2-9272417N-WB
						40°	1500lm	1050lm	FFS2-9274017N-WB
					3000K	24°	1600lm	1100lm	FFS2-9302417N-WB
						40°	1600lm	1100lm	FFS2-9304017N-WB
					4000K	24°	1800lm	1200lm	FFS2-9402417N-WB
						40°	1800lm	1200lm	FFS2-9404017N-WB

Code Remark: N=N(No Driver) F=F(ON-OFF) P=P(Phase Dim) A=A(1-10V Dim) D=D(DALI Dim)

Trimless Version

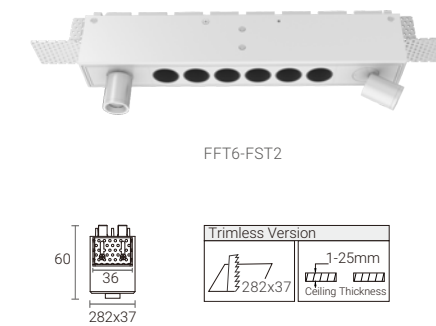

Coding

Model	CRI/ CCT	Beam Angle	LED Power	Control	Finish	Reflector Color	Accessory
FFS2 FUSION FFS2	927 CRI>90/ 2700K	24°	17 17W	N No Driver	W White	N None	
FFS4 FUSION FFS4	930 CRI>90/ 3000K	40°		F On-Off	B Black		
	940 CRI>90/ 4000K			P Phase Dim			
				A 1-10V Dim			
				D DALI Dim			

*In same BRIDGELUX LED chip as FUSION G2 series is optional.

NEW

FUSION G2 Fixed



FUSION G2 FF1
2W/ 200lm @CRI90 3000K



FUSION G2 FF2
4W/ 400lm @CRI90 3000K



FUSION G2 FF3
6W/ 580lm @CRI90 3000K



FUSION G2 FF5
11W/ 900lm @CRI90 3000K



FUSION G2 FF10
22W/ 1900lm @CRI90 3000K

FUSION G2 Trimless Fixed



FUSION G2 FFT5
11W/ 900lm @CRI90 3000K



FUSION G2 FFT10
22W/ 1900lm @CRI90 3000K

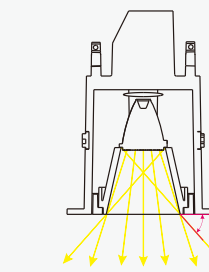

50° Shielding Angle:50°

FUSION

LED: OSRAM
Beam: 24°, 40°
Shielding Angle: 50°
UGR: <16

VS

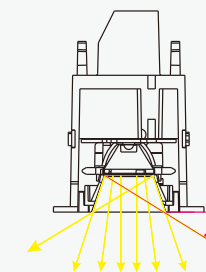

35° Shielding Angle:35°

FUSION G2

LED: Bridgelux
Beam:15°, 24°, 48°, 60°
Shielding Angle: 35°
UGR:<19
Higher Efficiency
Higher R9 Value

FUSION G2 Adjustable



FUSION G2 FA5
11W/ 900lm @CRI90 3000K



FUSION G2 FA10
22W/ 1900lm @CRI90 3000K

Beam Angles

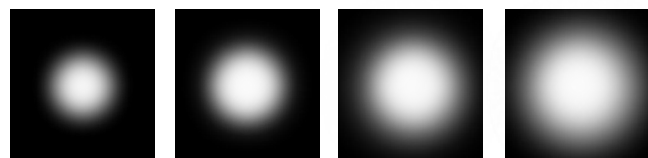

Spot 15° Medium 24° Flood 48° Wide Flood 60°

Finsh



White



Black

FUSION G2 FF1 – Fixed LED Downlight

NEW

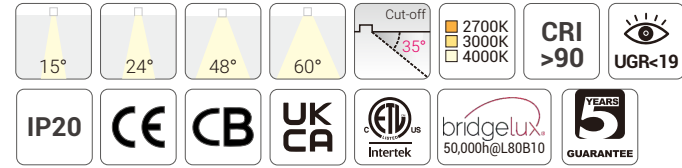

Quick Info

- Ceiling Cut-out: 37x37mm
- BRIDGELUX LED: 2W, CRI>90
- CCT: 2700K, 3000K, 4000K Available as Standard
- Beam Angle: 15°, 24°, 48°, 60°
- Lumen Output: Up to 220lm System Luminous Flux
- IP Class: IP20
- LED Driver: On-Off, Phase Dim, 1-10V Dim, DALI Dim

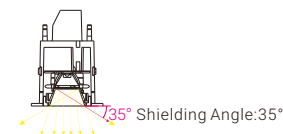
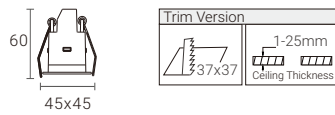

Light Distribution

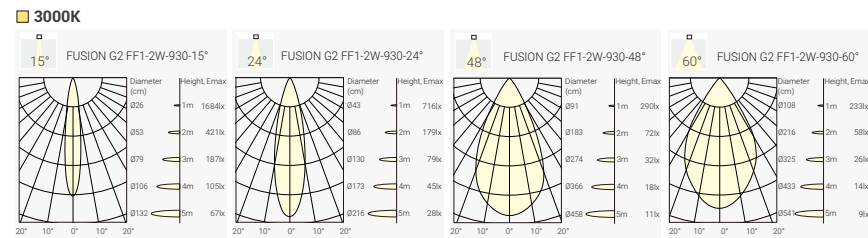

Finish

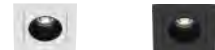

White Black

Order Info (FUSION G2 FF1 in White Trim & Black Reflector as an Example)

LED Power	System Power	LED Voltage	LED Current	CRI	CCT	Beam	LED Output	System Output	Code
2W	3W	3V	700mA	90	2700K	15°	230lm	190lm	FF1G2-9271502N-WB
						24°	230lm	180lm	FF1G2-9272402N-WB
						48°	230lm	180lm	FF1G2-9274802N-WB
						60°	230lm	180lm	FF1G2-9276002N-WB
				3000K	15°	240lm	200lm	200lm	FF1G2-9301502N-WB
					24°	240lm	190lm	190lm	FF1G2-9302402N-WB
					48°	240lm	190lm	190lm	FF1G2-9304802N-WB
					60°	240lm	190lm	190lm	FF1G2-9306002N-WB
				4000K	15°	260lm	220lm	220lm	FF1G2-9401502N-WB
					24°	260lm	200lm	200lm	FF1G2-9402402N-WB
					48°	260lm	200lm	200lm	FF1G2-9404802N-WB
					60°	260lm	200lm	200lm	FF1G2-9406002N-WB

Code Remark: N=N(No Driver) F=F(ON-OFF) P=P(Phase Dim) A=A(1-10V Dim) D=D(DALI Dim)

Coding

Model	CRI/ CCT	Beam Angle	LED Power	Control	Finish	Reflector Color	Accessory
FF1G2	927	15°	02	N	W	B	
FUSION G2 FF1	CRI>90/ 2700K	15°	2W	No Driver	White	Black	
	930	24°		F	B		
	CRI>90/ 3000K	24°		On-Off	Black		
	940	48°		P			
	CRI>90/ 4000K	48°		Phase Dim			
		60°		A			
		60°		1-10V Dim			
				D			
				DALI Dim			

FUSION G2 FF2 – Fixed LED Downlight

NEW

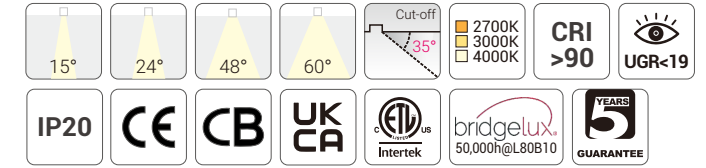

Quick Info

- Ceiling Cut-out: 68x37mm
- BRIDGELUX LED: 4W, CRI>90
- CCT: 2700K, 3000K, 4000K Available as Standard
- Beam Angle: 15°, 24°, 48°, 60°
- Lumen Output: Up to 420lm System Luminous Flux
- IP Class: IP20
- LED Driver: On-Off, Phase Dim, 1-10V Dim, DALI Dim

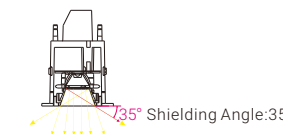
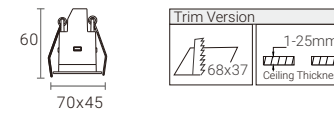

Light Distribution

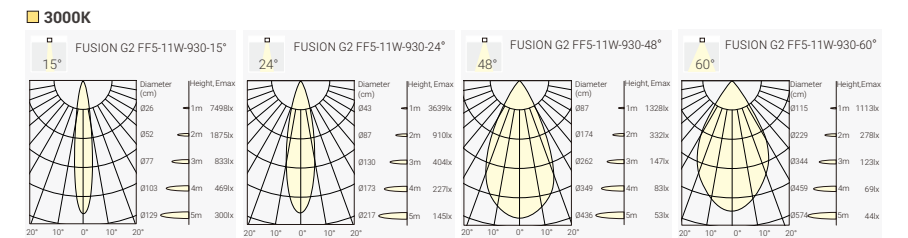

Finish



White Black

Order Info (FUSION G2 FF2 in White Trim & Black Reflector as an Example)

LED Power	System Power	LED Voltage	LED Current	CRI	CCT	Beam	LED Output	System Output	Code
4W	6W	6V	700mA	90	2700K	15°	460lm	380lm	FF2G2-8271510N-WB
						24°	460lm	350lm	FF2G2-8272410N-WB
						48°	460lm	350lm	FF2G2-8274810N-WB
						60°	460lm	350lm	FF2G2-8276010N-WB
				3000K	15°	480lm	400lm	400lm	FF2G2-8301510N-WB
					24°	480lm	360lm	360lm	FF2G2-8302410N-WB
					48°	480lm	360lm	360lm	FF2G2-8304810N-WB
					60°	480lm	360lm	360lm	FF2G2-8306010N-WB
				4000K	15°	510lm	420lm	420lm	FF2G2-8401510N-WB
					24°	510lm	380lm	380lm	FF2G2-8402410N-WB
					48°	510lm	380lm	380lm	FF2G2-8404810N-WB
					60°	510lm	380lm	380lm	FF2G2-8406010N-WB

Code Remark: N=N(No Driver) F=F(ON-OFF) P=P(Phase Dim) A=A(1-10V Dim) D=D(DALI Dim)

Coding

Model	CRI/ CCT	Beam Angle	LED Power	Control	Finish	Reflector Color	Accessory
FF2G2	927	15°	04	N	W	B	
FUSION G2 FF2	CRI>90/ 2700K	15°	4W	No Driver	White	Black	
	930	24°		F	B		
	CRI>90/ 3000K	24°		On-Off	Black		
	940	48°		P			
	CRI>90/ 4000K	48°		Phase Dim			
		60°		A			
		60°		1-10V Dim			
				D			
				DALI Dim			

FUSION G2 FF3 – Fixed LED Downlight

NEW

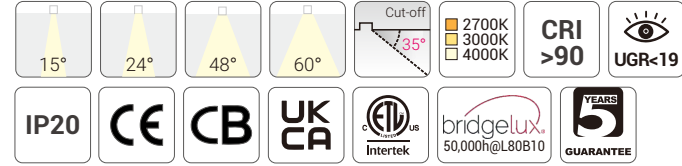

Quick Info

- Ceiling Cut-out: 90x37mm
- BRIDGELUX LED: 7W, CRI>90
- CCT: 2700K, 3000K, 4000K Available as Standard
- Beam Angle: 15°, 24°, 48°, 60°
- Lumen Output: Up to 600lm System Luminous Flux
- IP Class: IP20
- LED Driver: On-Off, Phase Dim, 1-10V Dim, DALI Dim

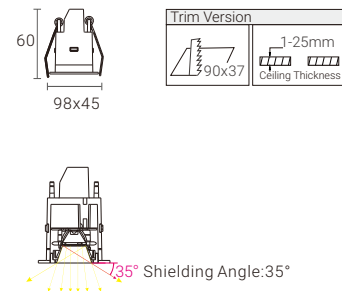

Light Distribution

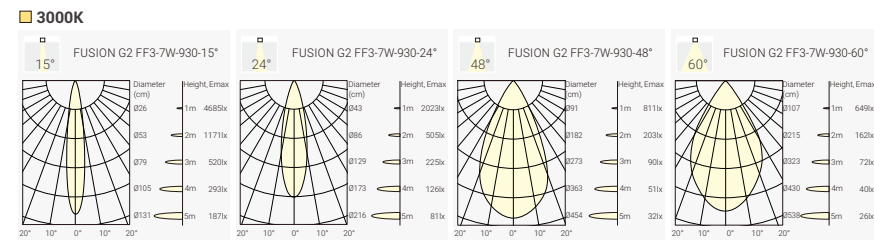

Finish



Order Info (FUSION G2 FF3 in White Trim & Black Reflector as an Example)

LED Power	System Power	LED Voltage	LED Current	CRI	CCT	Beam	LED Output	System Output	Code
7W	9W	9V	700mA	80	2700K	15°	700lm	560lm	FF3G2-9271507N-WB
						24°	700lm	500lm	FF3G2-9272407N-WB
						48°	700lm	500lm	FF3G2-9274807N-WB
						60°	700lm	500lm	FF3G2-9276007N-WB
				3000K		15°	720lm	580lm	FF3G2-9301507N-WB
						24°	720lm	520lm	FF3G2-9302407N-WB
						48°	720lm	520lm	FF3G2-9304807N-WB
						60°	720lm	520lm	FF3G2-9306007N-WB
				4000K		15°	780lm	600lm	FF3G2-9401507N-WB
						24°	780lm	550lm	FF3G2-9402407N-WB
						48°	780lm	550lm	FF3G2-9404807N-WB
						60°	780lm	550lm	FF3G2-9406007N-WB

Code Remark: N=N(No Driver) F=F(ON-OFF) P=P(Phase Dim) A=A(1-10V Dim) D=D(DALI Dim)

Coding

FF3G2 - * ** ** * - ***

Model	CRI/ CCT	Beam Angle	LED Power	Control	Finish	Reflector Color	Accessory
FF3G2 FUSION G2 FF3	927 CRI>90/ 2700K	15°	07 7W	N No Driver	W White	B Black	
	930 CRI>90/ 3000K	24°		F On-Off	B Black		
	940 CRI>90/ 4000K	48°		P Phase Dim			
		60°		A 1-10V Dim			
		60°		D DALI Dim			

FUSION G2 FF5 – Fixed LED Downlight

NEW

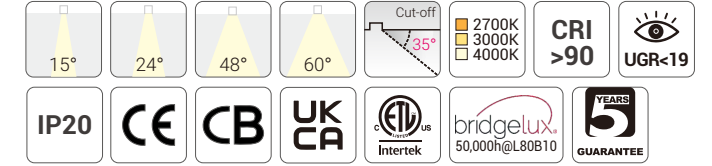

Quick Info

- Ceiling Cut-out: 144x37mm for Trim Version
- BRIDGELUX LED: 11W, CRI>90
- CCT: 2700K, 3000K, 4000K Available as Standard
- Beam Angle: 15°, 24°, 48°, 60°
- Lumen Output: Up to 950lm System Luminous Flux
- IP Class: IP20
- LED Driver: On-Off, Phase Dim, 1-10V Dim, DALI Dim, Casambi Wireless Dim

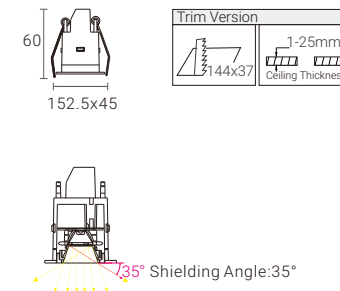

Light Distribution

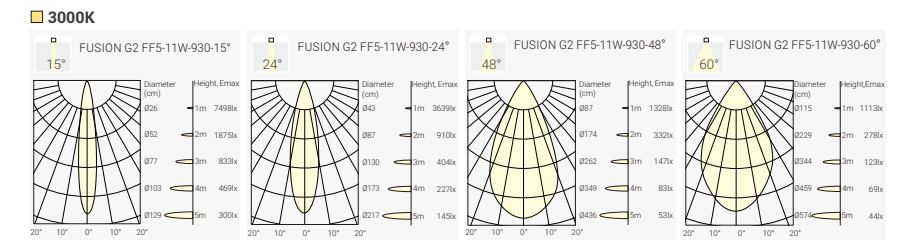

Finish

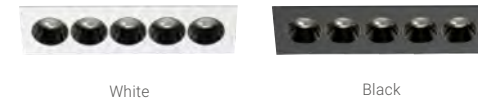

Order Info (FUSION G2 FF5 in White Trim & Black Reflector as an Example)

LED Power	System Power	LED Voltage	LED Current	CRI	CCT	Beam	LED Output	System Output	Code
11W	13W	15V	700mA	90	2700K	15°	1150lm	870lm	FF5G2-9271511N-WB
						24°	1150lm	830lm	FF5G2-9272411N-WB
						48°	1150lm	830lm	FF5G2-9274811N-WB
						60°	1150lm	830lm	FF5G2-9276011N-WB
				3000K		15°	1200lm	900lm	FF5G2-9301511N-WB
						24°	1200lm	850lm	FF5G2-9302411N-WB
						48°	1200lm	850lm	FF5G2-9304811N-WB
						60°	1200lm	850lm	FF5G2-9306011N-WB
				4000K		15°	1300lm	950lm	FF5G2-9401511N-WB
						24°	1300lm	900lm	FF5G2-9402411N-WB
						48°	1300lm	900lm	FF5G2-9404811N-WB
						60°	1300lm	900lm	FF5G2-9406011N-WB

Code Remark: N=N(No Driver) F=F(ON-OFF) P=P(Phase Dim) A=A(1-10V Dim) D=D(DALI Dim)

Trimless Version

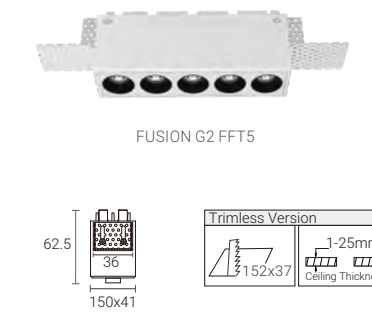

Coding

FF5G2 - * ** ** * - ***

Model	CRI/ CCT	Beam Angle	LED Power	Control	Finish	Reflector Color	Accessory
FF5G2 FUSION G2 FF5	927 CRI>90/ 2700K	15°	11 11W	N No Driver	W White	B Black	
FF5G2 FUSION G2 FF5	930 CRI>90/ 3000K	24°		F On-Off	B Black		
	940 CRI>90/ 4000K	48°		P Phase Dim			
		60°		A 1-10V Dim			
		60°		D DALI Dim			

FUSION G2 FF10 – Fixed LED Downlight

NEW

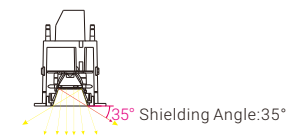
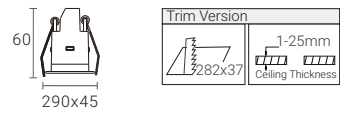
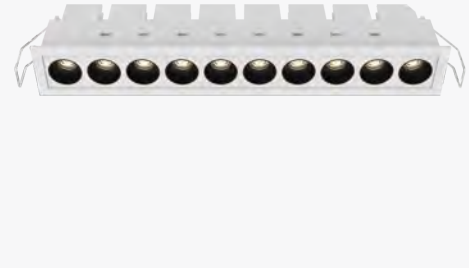

Finish



White



Black

Trimless Version



FUSION G2 FFT10

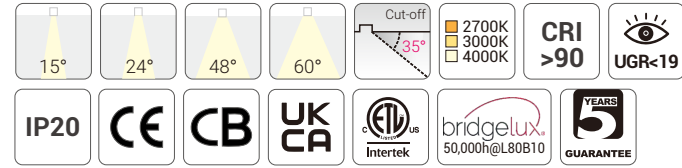
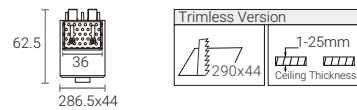

Quick Info

- Ceiling Cut-out: 282x37mm for Trim Version
- BRIDGELUX LED: 22W, CRI>90
- CCT: 2700K, 3000K, 4000K Available as Standard
- Beam Angle: 15°, 24°, 48°, 60°
- Lumen Output: Up to 2000lm System Luminous Flux
- IP Class: IP20
- LED Driver: On-Off, Phase Dim, 1-10V Dim, DALI Dim, Casambi Wireless Dim

Light Distribution

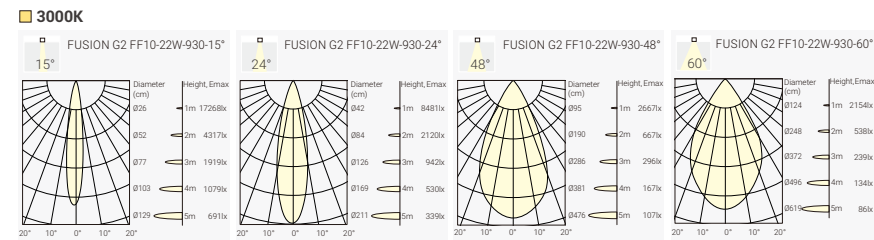

Order Info (FUSION G2 FF10 in White Trim & Black Reflector as an Example)

LED Power	System Power	LED Voltage	LED Current	CRI	CCT	Beam	LED Output	System Output	Code
22W	24W	30V	700mA	90	2700K	15°	2300lm	1850lm	FF10G2-9271522N-WB
						24°	2300lm	1800lm	FF10G2-9272422N-WB
						48°	2300lm	1800lm	FF10G2-9274822N-WB
						60°	2300lm	1850lm	FF10G2-9276022N-WB
						15°	2450lm	1900lm	FF10G2-9301522N-WB
						24°	2450lm	1850lm	FF10G2-9302422N-WB
					4000K	48°	2450lm	1850lm	FF10G2-9304822N-WB
						60°	2450lm	1900lm	FF10G2-9306022N-WB
						15°	2600lm	2000lm	FF10G2-9401522N-WB
						24°	2600lm	1950lm	FF10G2-9402422N-WB
						48°	2600lm	1950lm	FF10G2-9404822N-WB
						60°	2600lm	2000lm	FF10G2-9406022N-WB

Code Remark: N=N(No Driver) F=F(ON-OFF) P=P(Phase Dim) A=A(1-10V Dim) D=D(DALI Dim)

Coding

Model	CRI/ CCT	Beam Angle	LED Power	Control	Finish	Reflector Color	Accessory
FF10G2	927	15	22	N	W	B	
FUSION G2 FF10	CRI>90/ 2700K	15°	22W	No Driver	White	Black	
FFT10G2	930	24		F	B		
FUSION G2 FFT10	CRI>90/ 3000K	24°		On-Off	Black		
	940	48		P			
	CRI>90/ 4000K	48°		Phase Dim			
		60		A			
		60°		1-10V Dim			
				D			
				DALI Dim			

Project: Eggen Restaurant, Norway

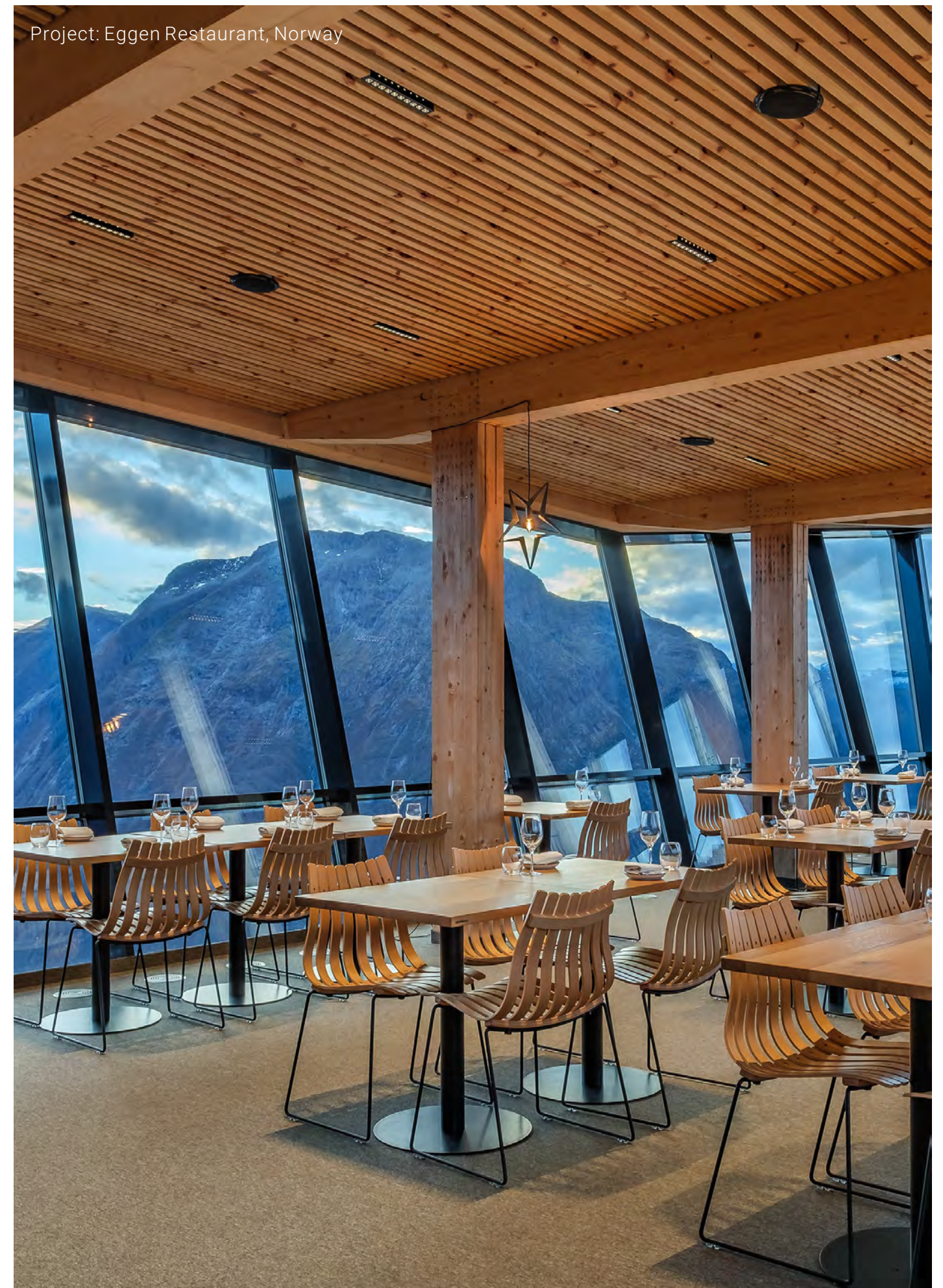

FUSION G2 FA5 – Adjustable LED Downlight

NEW

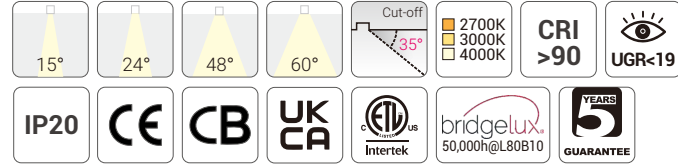

Quick Info

- Ceiling Cut-out: 160x53mm for Trim Version
- BRIDGELUX LED: 11W, CRI>90
- CCT: 2700K, 3000K, 4000K Available as Standard
- Beam Angle: 15°, 24°, 48°, 60°
- Lumen Output: Up to 950lm System Luminous Flux
- IP Class: IP20
- LED Driver: On-Off, Phase Dim, 1-10V Dim, DALI Dim, Casambi Wireless Dim

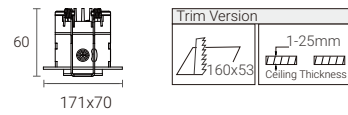

Light Distribution

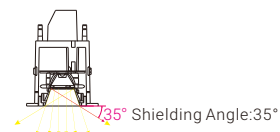
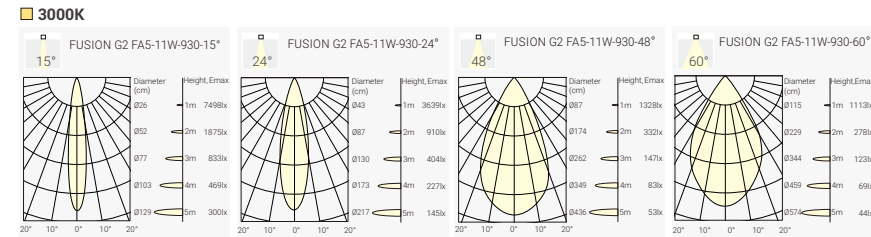

Finish



Order Info (FUSION G2 FA5 in White Trim & Black Reflector as an Example)

LED Power	System Power	LED Voltage	LED Current	CRI	CCT	Beam	LED Output	System Output	Code
11W	13W	15V	700mA	90	2700K	15°	1150lm	870lm	FA5G2-9271511N-WB
						24°	1150lm	830lm	FA5G2-9272411N-WB
						48°	1150lm	830lm	FA5G2-9274811N-WB
						60°	1150lm	830lm	FA5G2-9276011N-WB
					3000K	15°	1200lm	900lm	FA5G2-9301511N-WB
						24°	1200lm	850lm	FA5G2-9302411N-WB
						48°	1200lm	850lm	FA5G2-9304811N-WB
						60°	1200lm	850lm	FA5G2-9306011N-WB
					4000K	15°	1300lm	950lm	FA5G2-9401511N-WB
						24°	1300lm	900lm	FA5G2-9402411N-WB
						48°	1300lm	900lm	FA5G2-9404811N-WB
						60°	1300lm	900lm	FA5G2-9406011N-WB

Code Remark: N=N(No Driver) F=F(ON-OFF) P=P(Phase Dim) A=A(1-10V Dim) D=D(DALI Dim)

Coding

Model	CRI/ CCT	Beam Angle	LED Power	Control	Finish	Reflector Color	Accessory
FA5G2	927	15°	11	N	W	B	
FUSION G2 FA5	CRI>90/ 2700K	15°	11W	No Driver	White	Black	
	930	24°		F	B		
	CRI>90/ 3000K	24°		On-Off	Black		
	940	48°		P			
	CRI>90/ 4000K	48°		Phase Dim			
		60°		A			
		60°		1-10V Dim			
				D			
				DALI Dim			

FUSION G2 FA10 – Adjustable LED Downlight

NEW

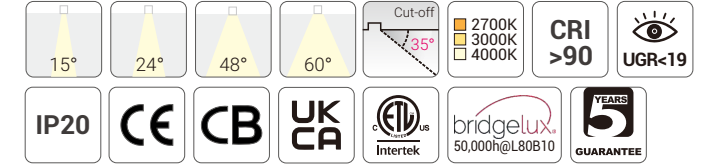

Quick Info

- Ceiling Cut-out: 198x53mm for Trim Version
- BRIDGELUX LED: 22W, CRI>90
- CCT: 2700K, 3000K, 4000K Available as Standard
- Beam Angle: 15°, 24°, 48°, 60°
- Lumen Output: Up to 2000lm System Luminous Flux
- IP Class: IP20
- LED Driver: On-Off, Phase Dim, 1-10V Dim, DALI Dim, Casambi Wireless Dim

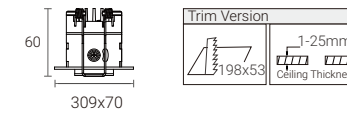

Light Distribution

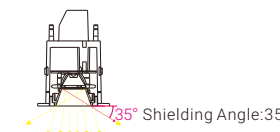
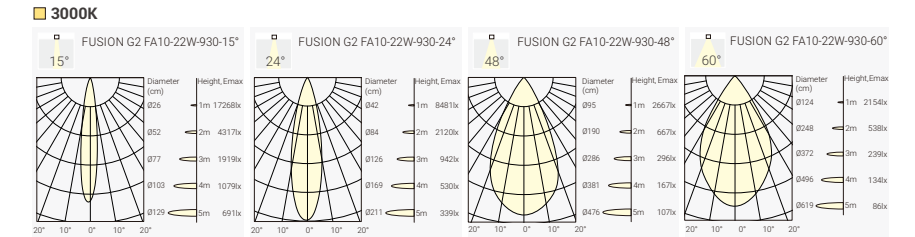

Finish

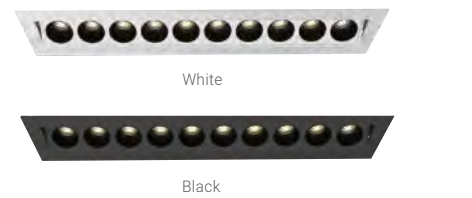

Order Info (FUSION G2 FA10 in White Trim & Black Reflector as an Example)

LED Power	System Power	LED Voltage	LED Current	CRI	CCT	Beam	LED Output	System Output	Code
22W	24W	30V	700mA	90	2700K	15°	2300lm	1850lm	FA10G2-9271522N-WB
						24°	2300lm	1800lm	FA10G2-9272422N-WB
						48°	2300lm	1800lm	FA10G2-9274822N-WB
						60°	2300lm	1850lm	FA10G2-9276022N-WB
					3000K	15°	2450lm	1900lm	FA10G2-9301522N-WB
						24°	2450lm	1850lm	FA10G2-9302422N-WB
						48°	2450lm	1850lm	FA10G2-9304822N-WB
						60°	2450lm	1900lm	FA10G2-9306022N-WB
					4000K	15°	2600lm	2000lm	FA10G2-9401522N-WB
						24°	2600lm	1950lm	FA10G2-9402422N-WB
						48°	2600lm	1950lm	FA10G2-9404822N-WB
						60°	2600lm	2000lm	FA10G2-9406022N-WB

Code Remark: N=N(No Driver) F=F(ON-OFF) P=P(Phase Dim) A=A(1-10V Dim) D=D(DALI Dim)

Coding

Model	CRI/ CCT	Beam Angle	LED Power	Control	Finish	Reflector Color	Accessory
FA10G2	927	15°	22	N	W	B	
FUSION G2 FA10	CRI>90/ 2700K	15°	22W	No Driver	White	Black	
	930	24°		F	B		
	CRI>90/ 3000K	24°		On-Off	Black		
	940	48°		P			
	CRI>90/ 4000K	48°		Phase Dim			
		60°		A			
		60°		1-10V Dim			
				D			
				DALI Dim			